



# Castle



70404





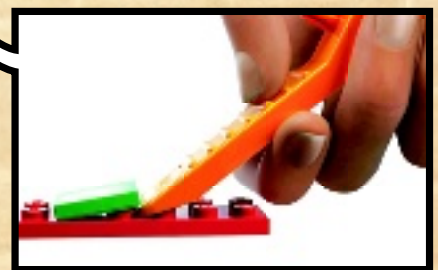
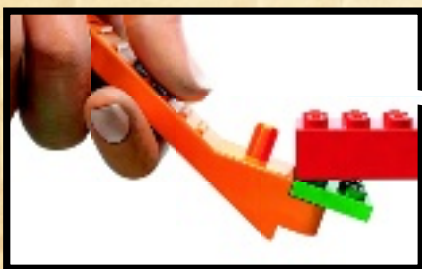



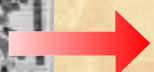
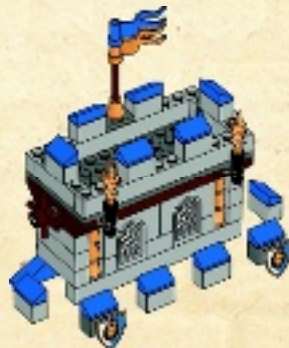
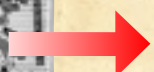
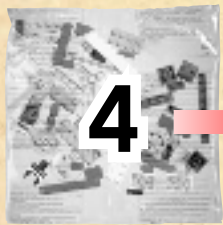
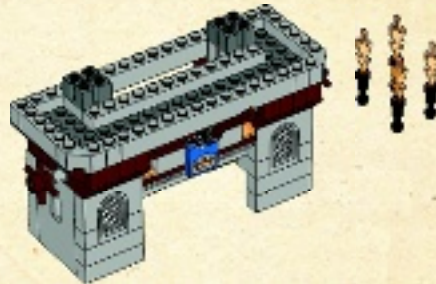
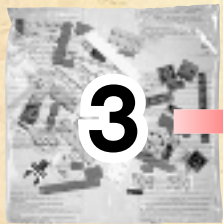
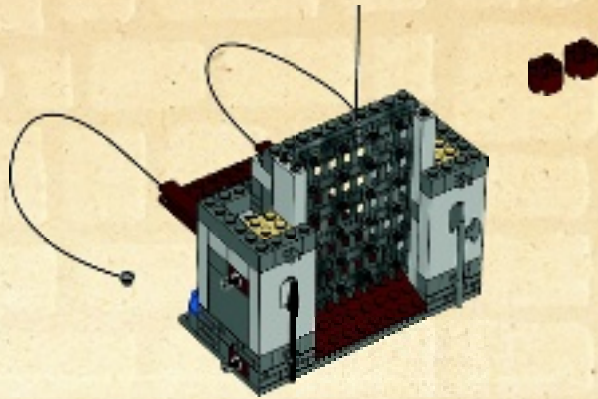
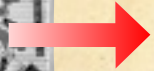
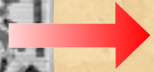





6

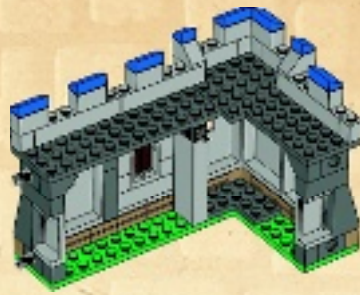

7

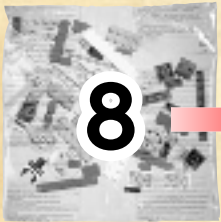
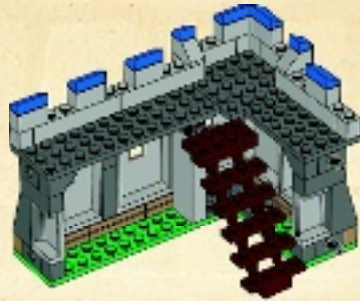
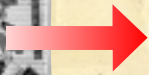

8

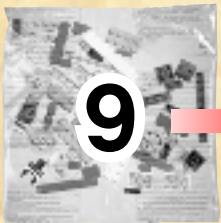
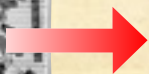

9



10

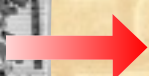



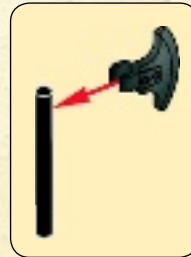
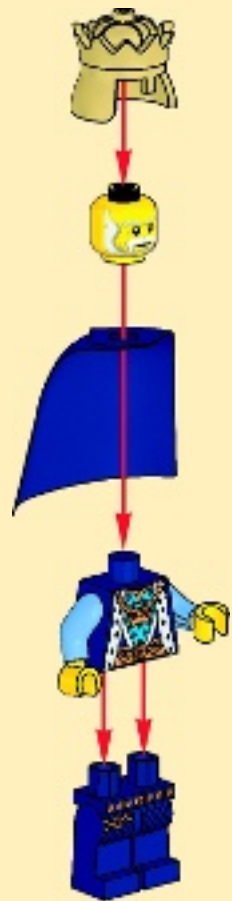



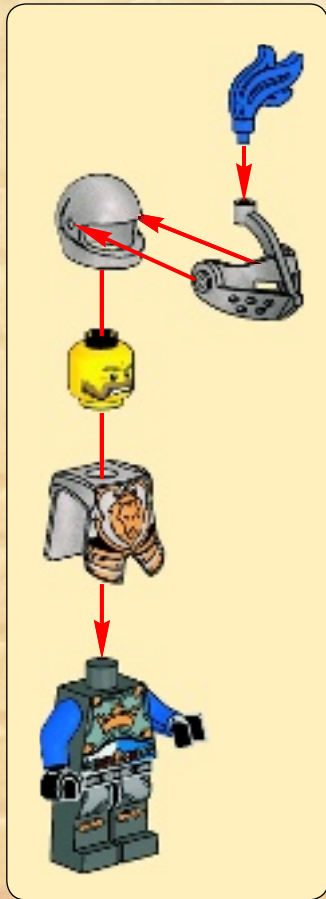

1

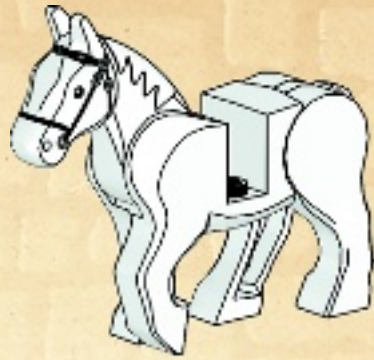

2

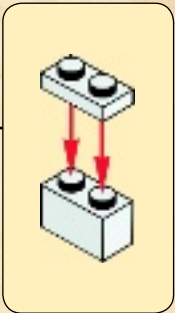
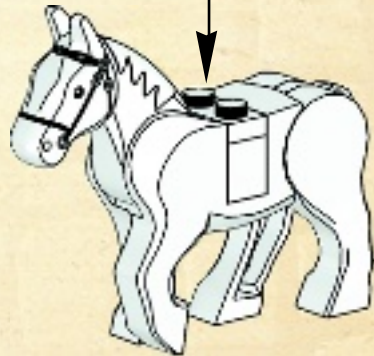

3





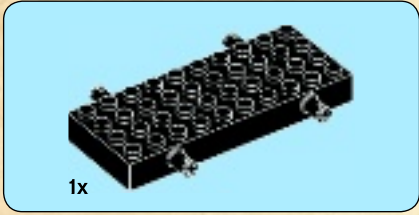
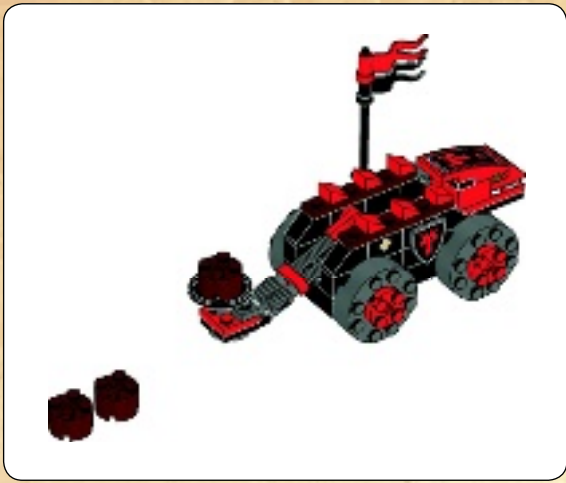

1

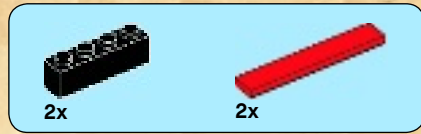
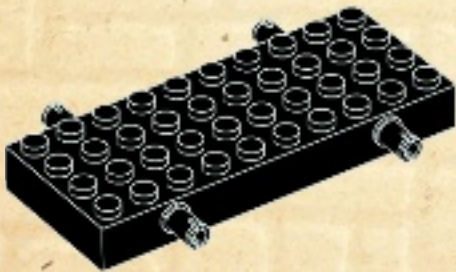

2

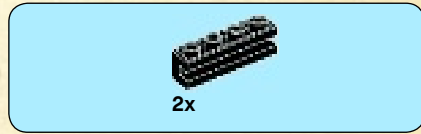
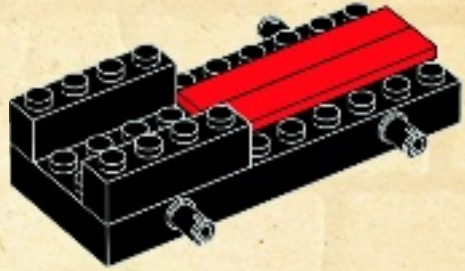

3

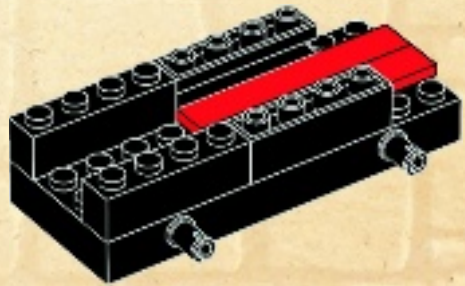



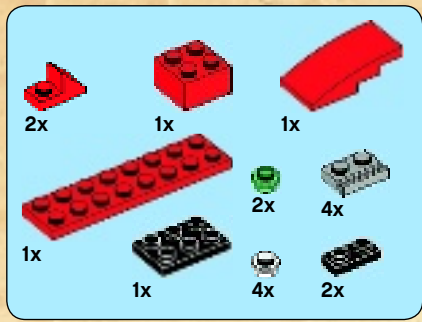

4

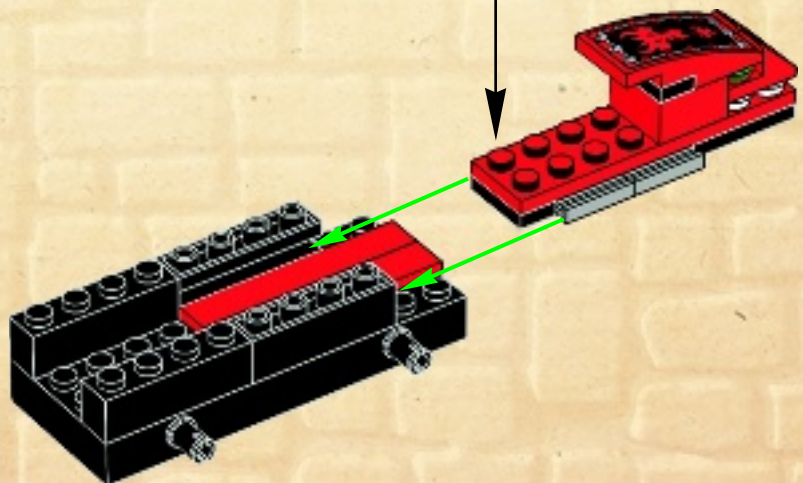
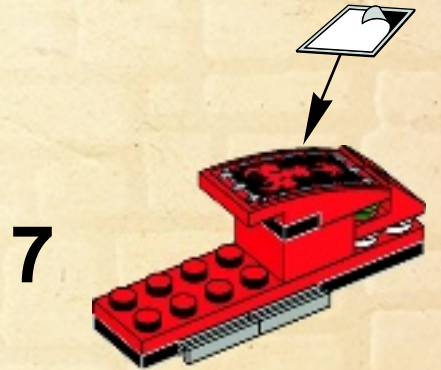
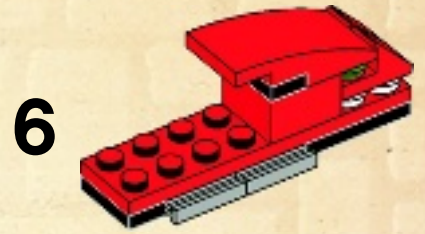
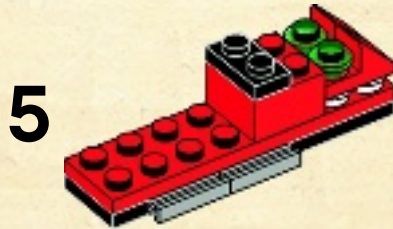
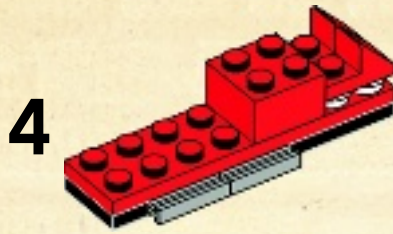
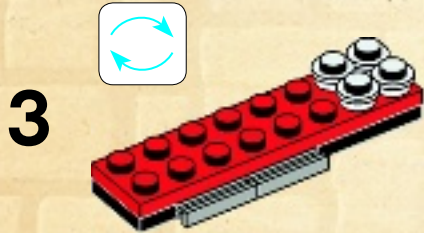
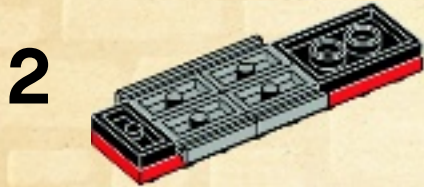



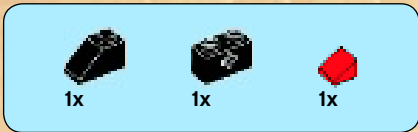

5

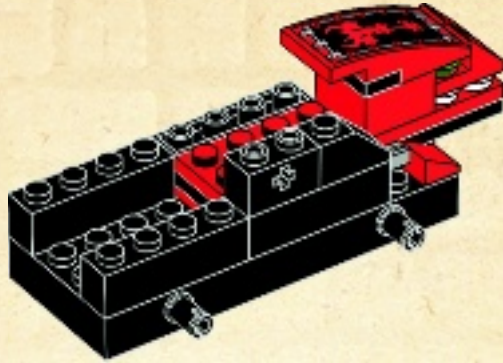

6

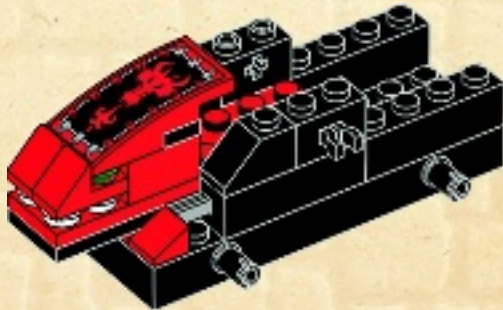
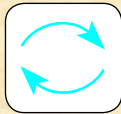





# 7

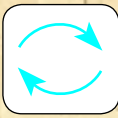

- 1
- 2
- 3

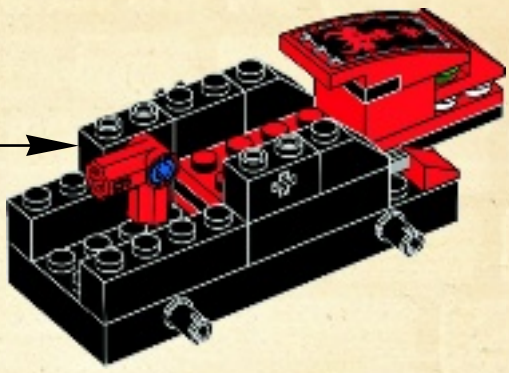

# 8

- 1
- 2
- 3

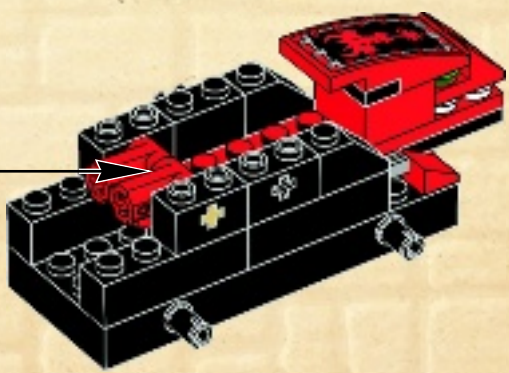



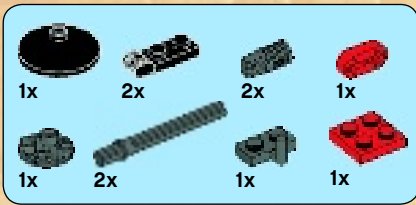

# 9

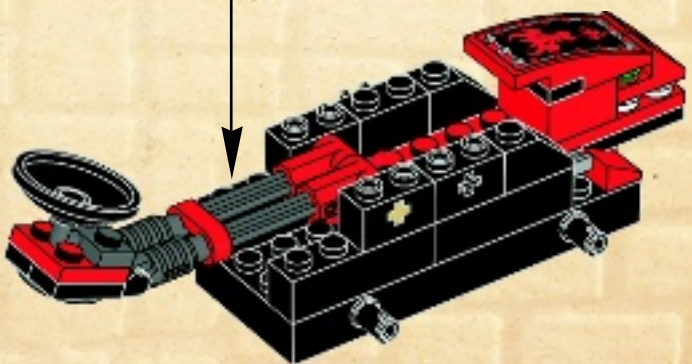
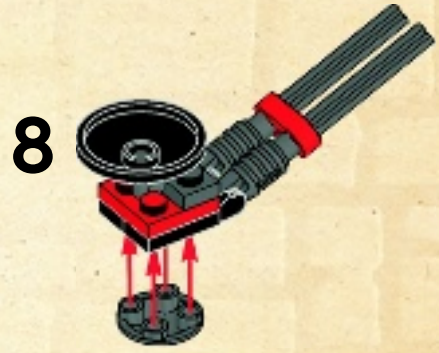
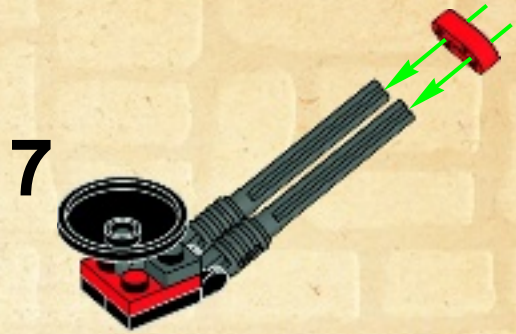
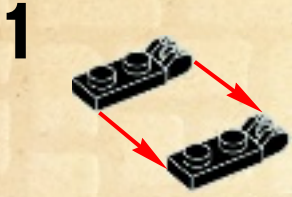





2x

10

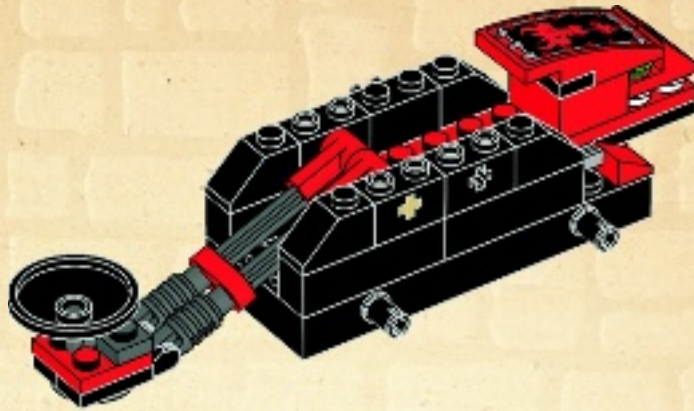

2x

11

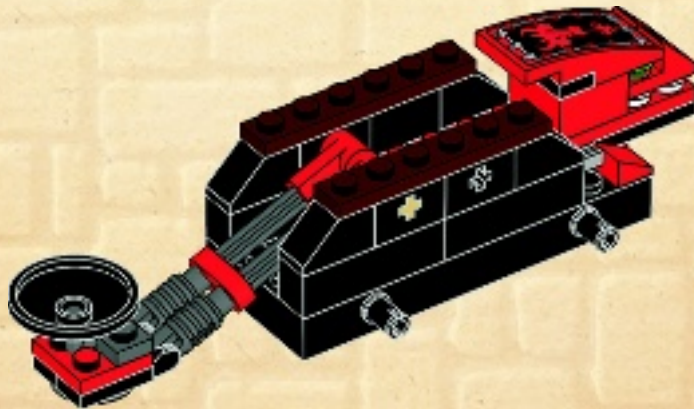





6x

# 12

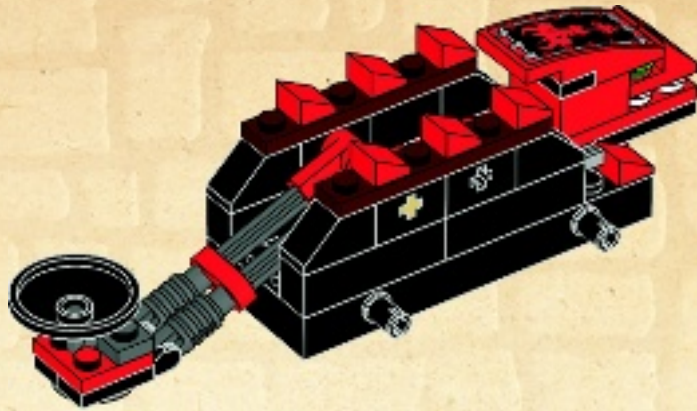

4x



4x

# 13



4x

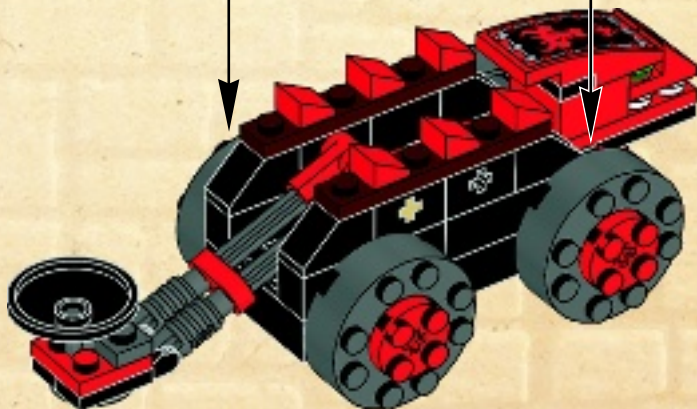



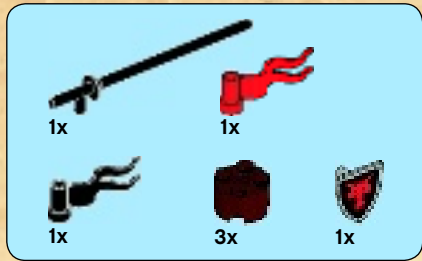

14

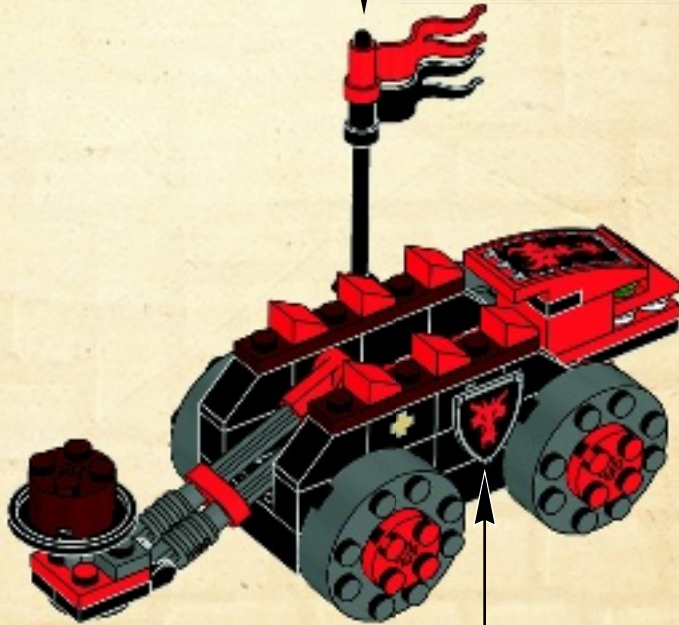
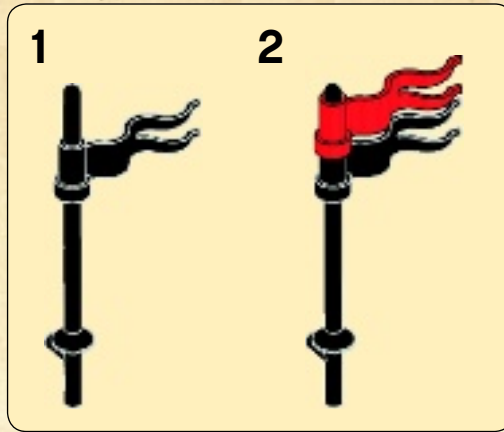



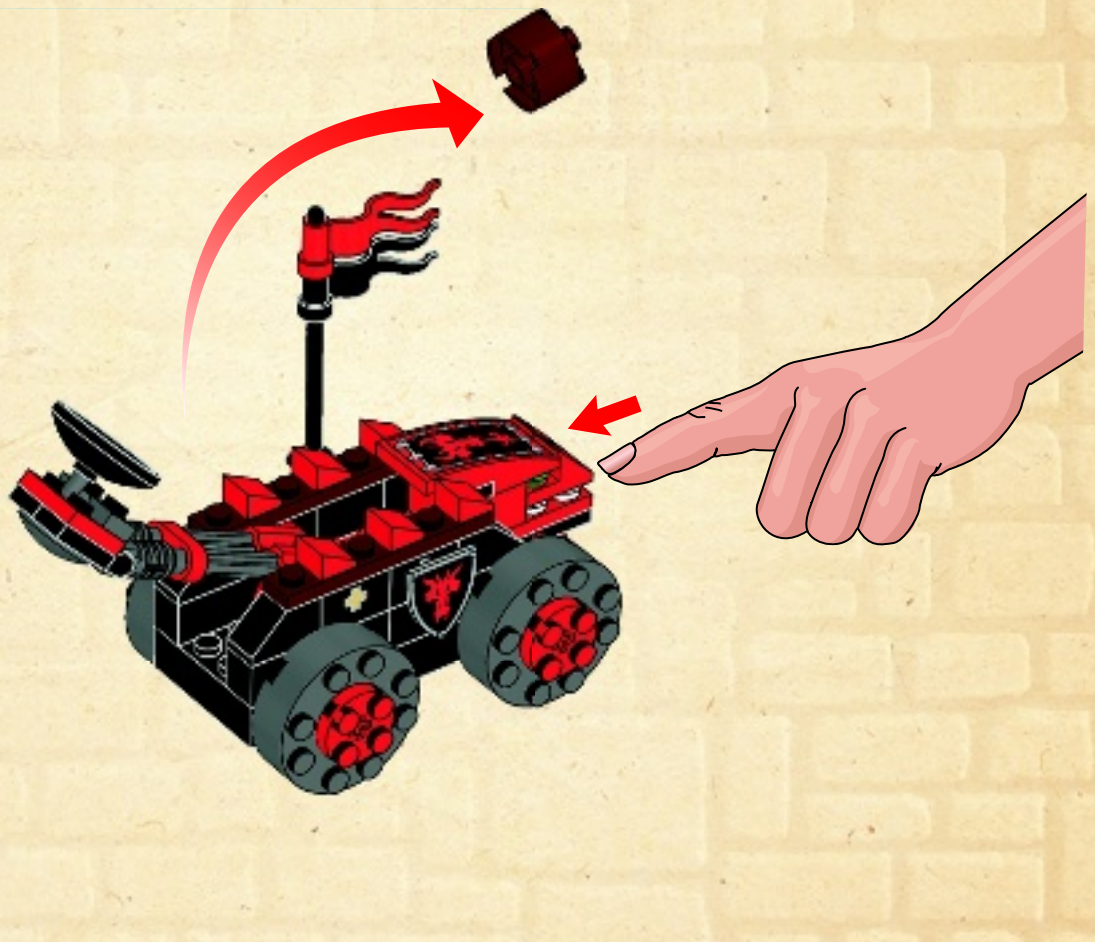



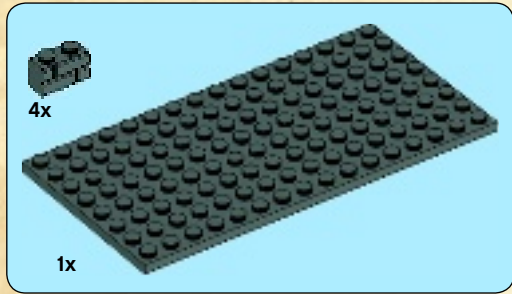
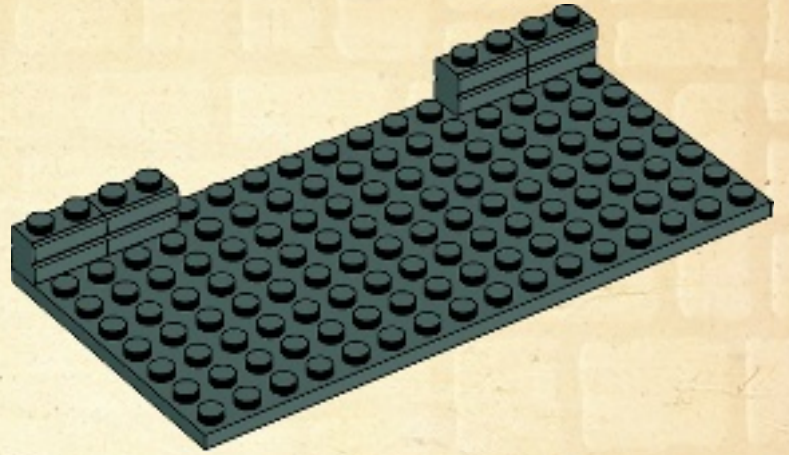
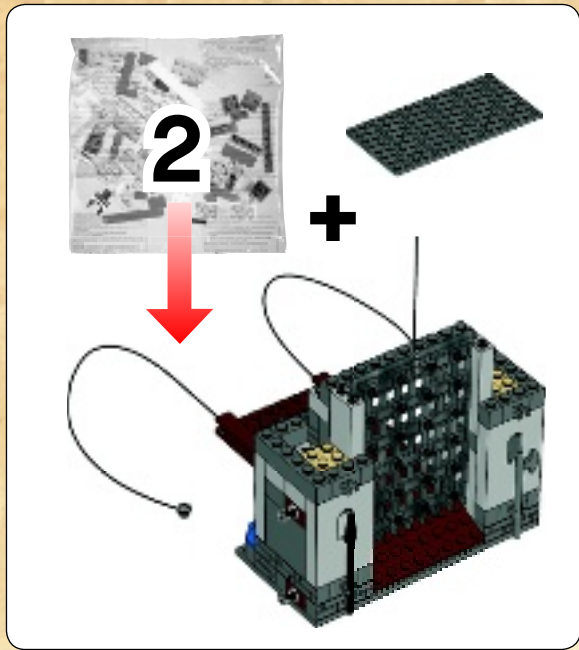

1



2

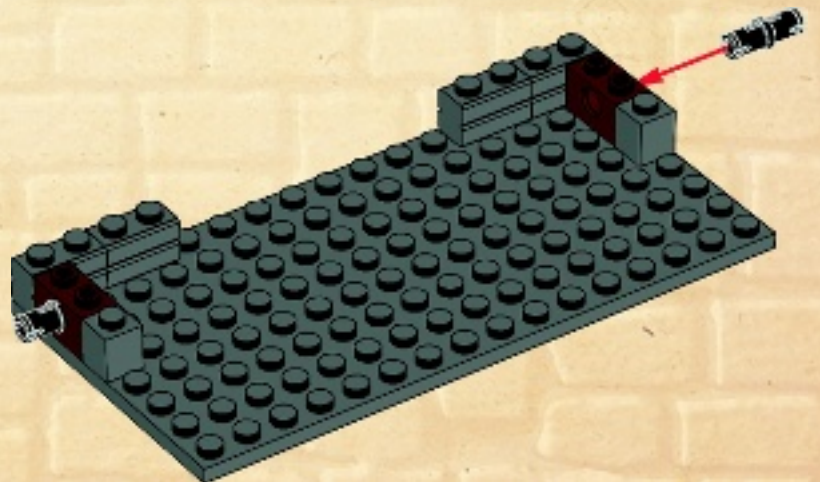



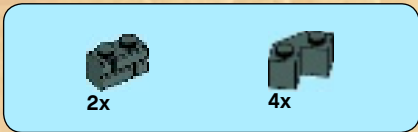

3

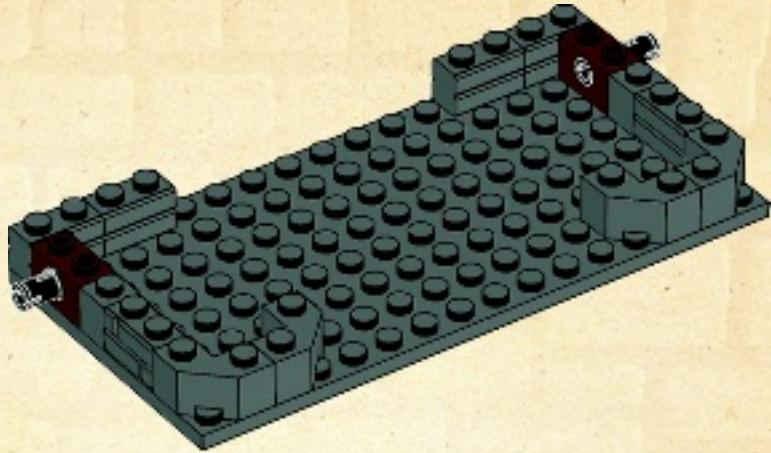

4

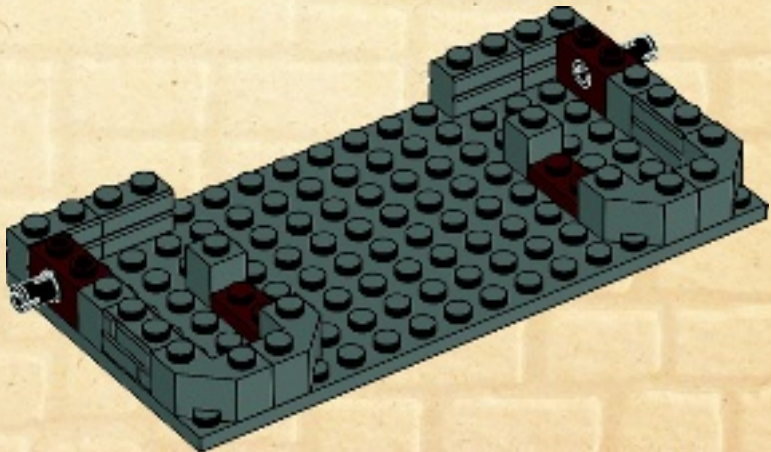





5

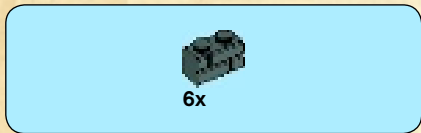
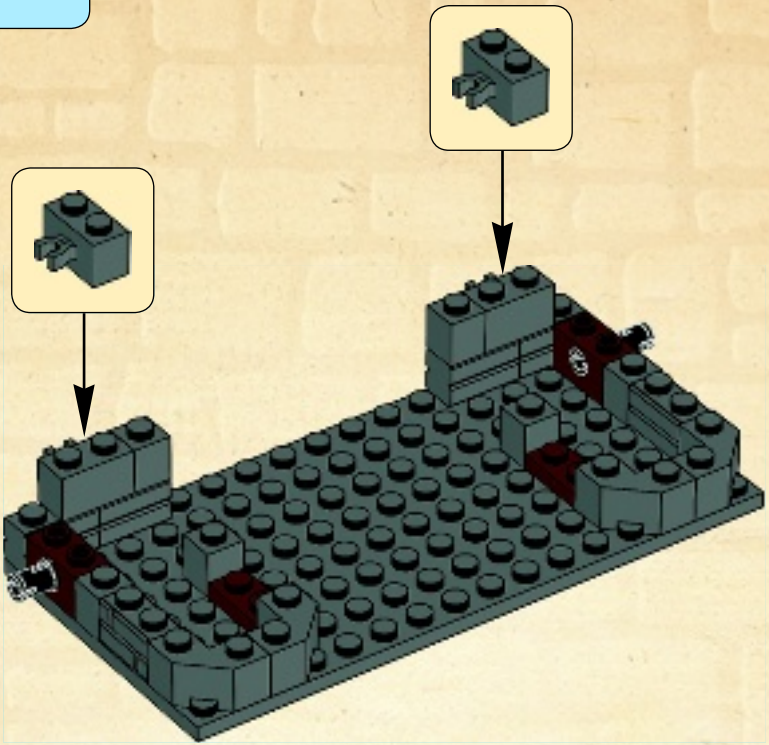

6

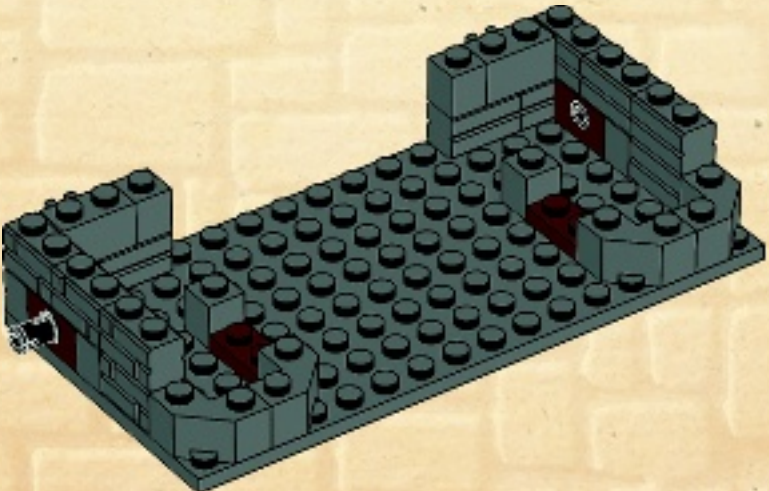



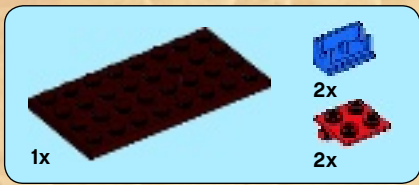

7

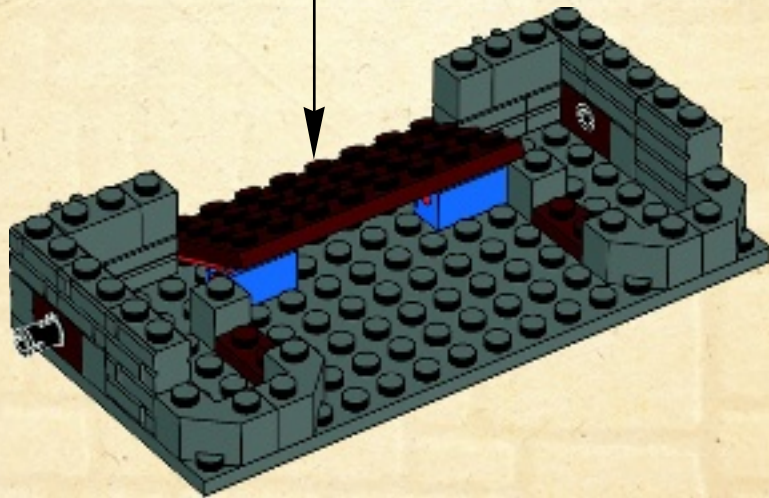
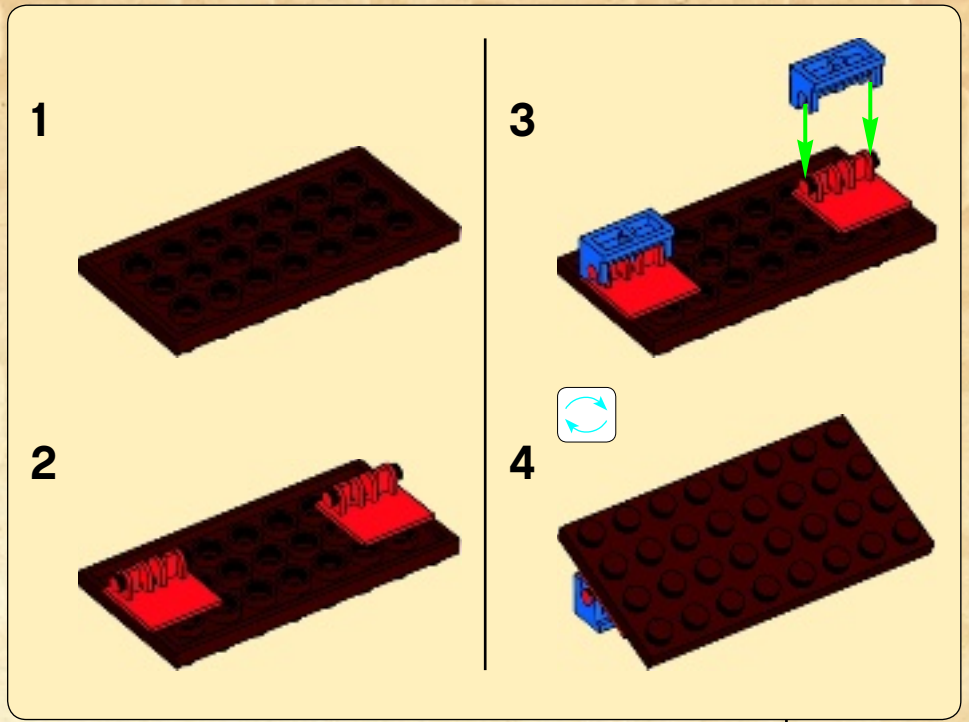



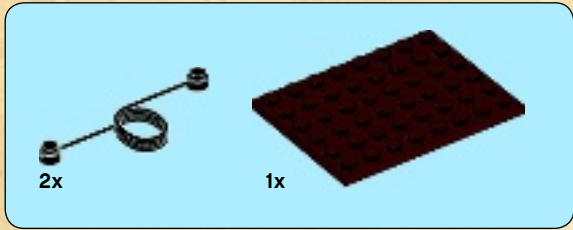

1

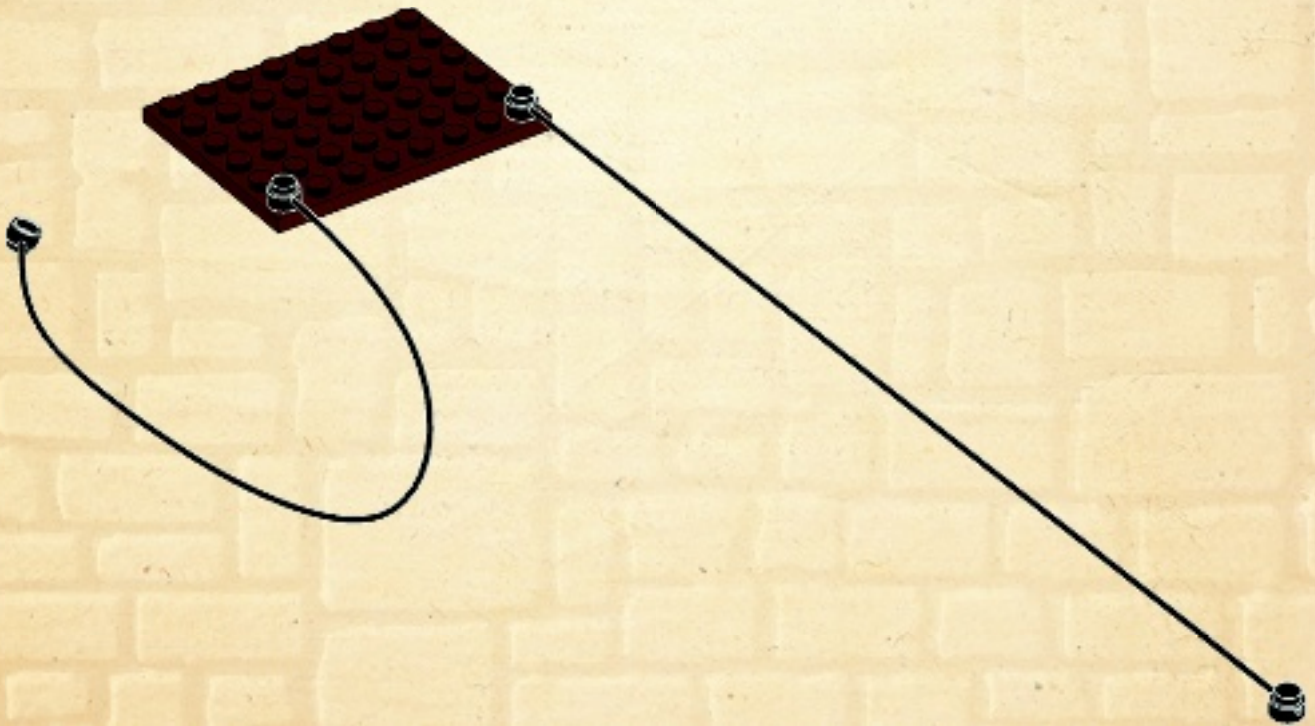



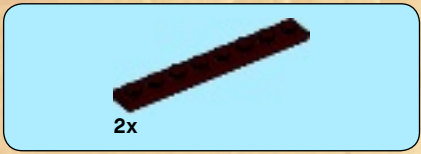

2

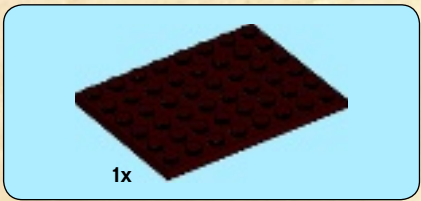
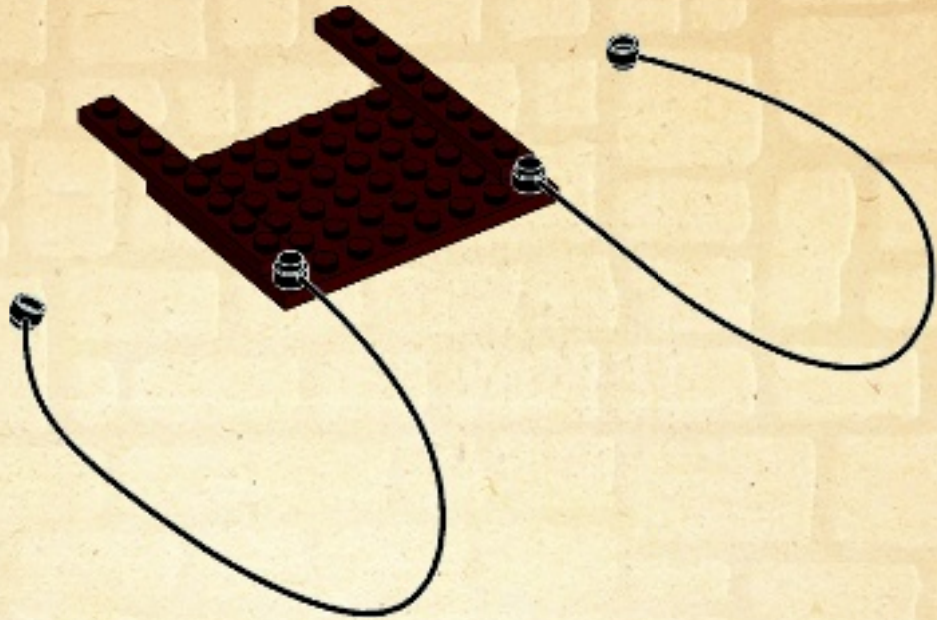

3

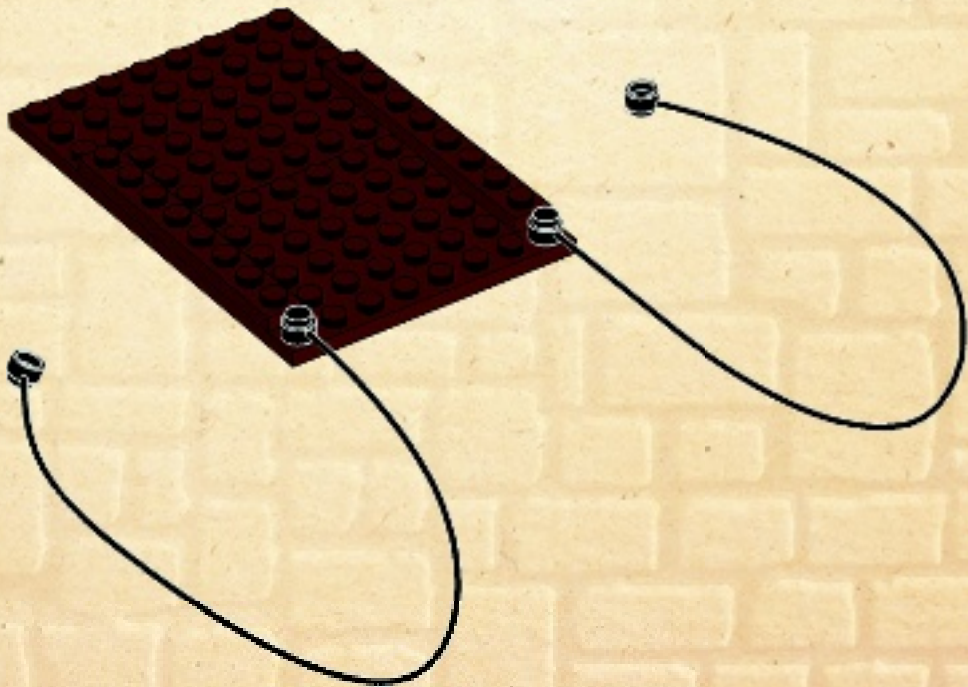



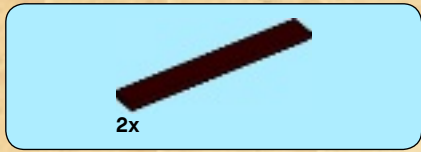

4

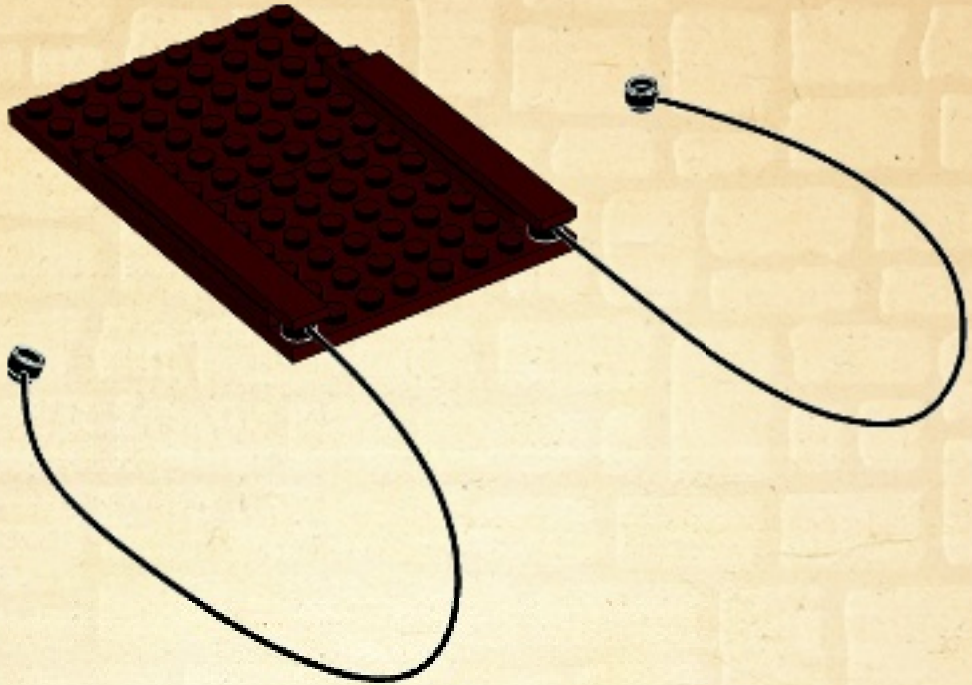

5

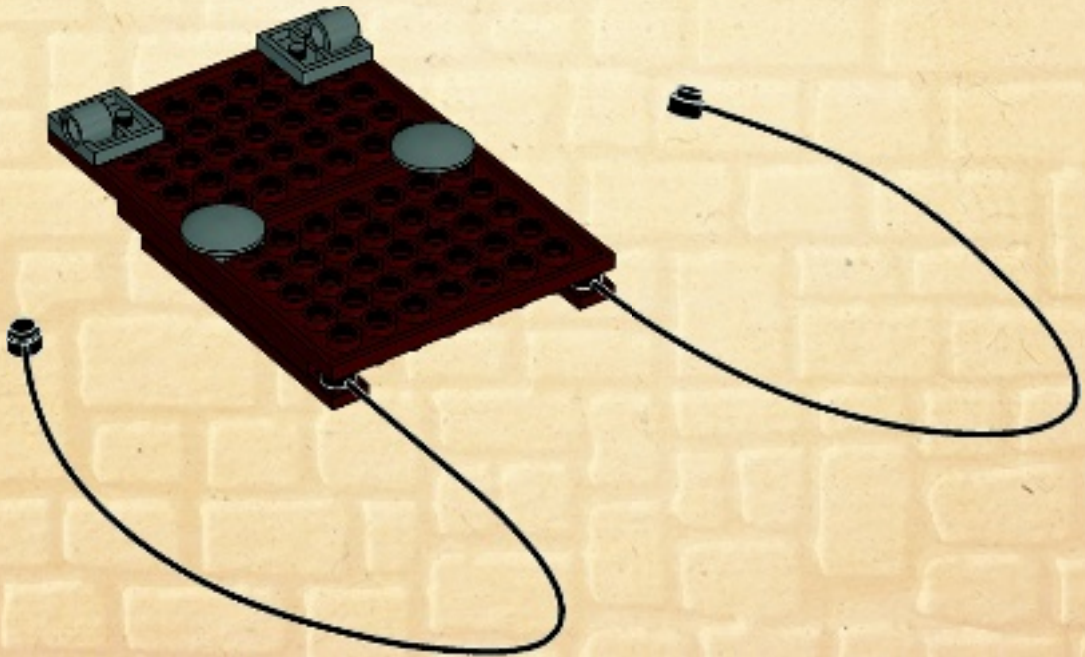
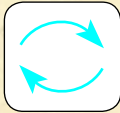



2x



6

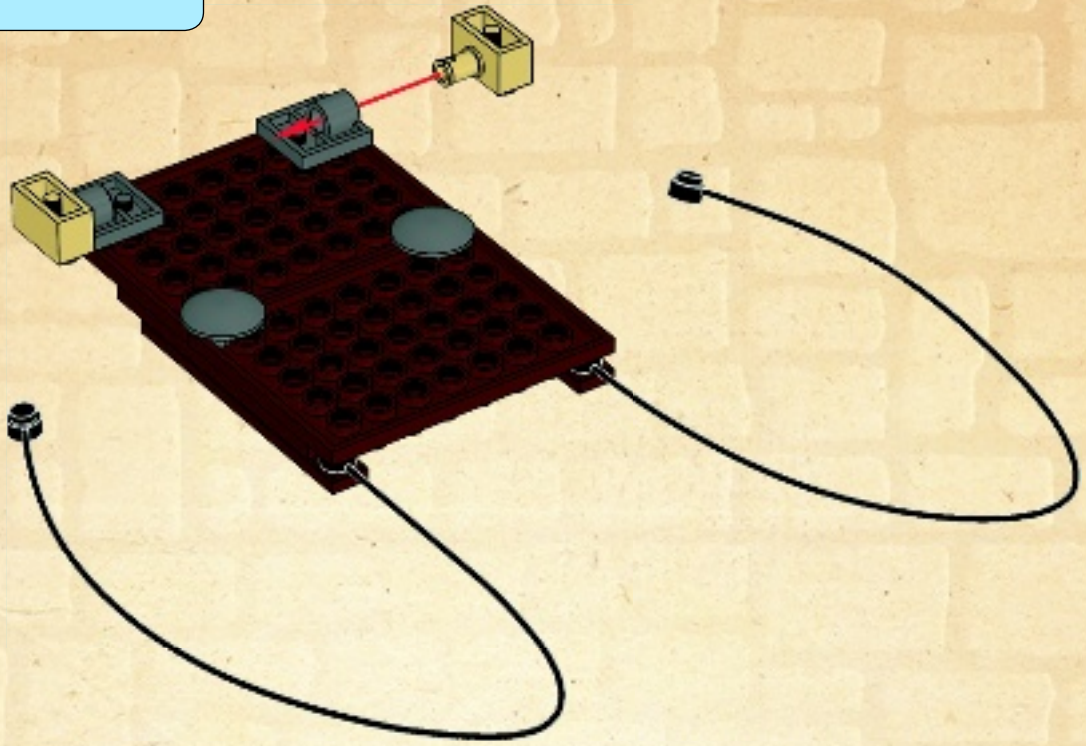

7

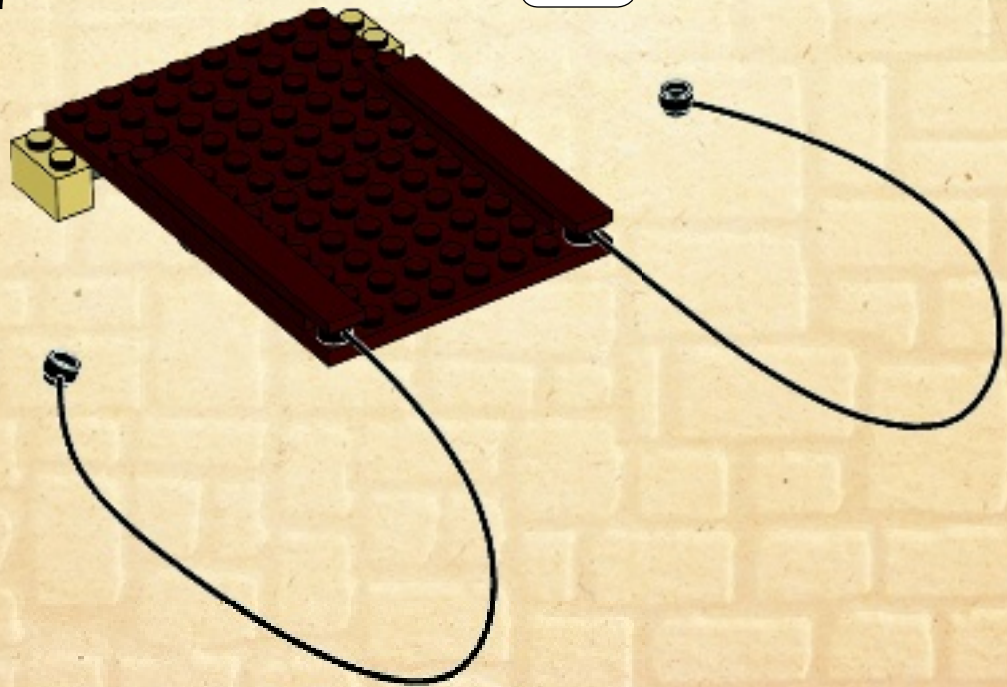
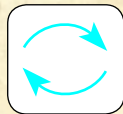



8

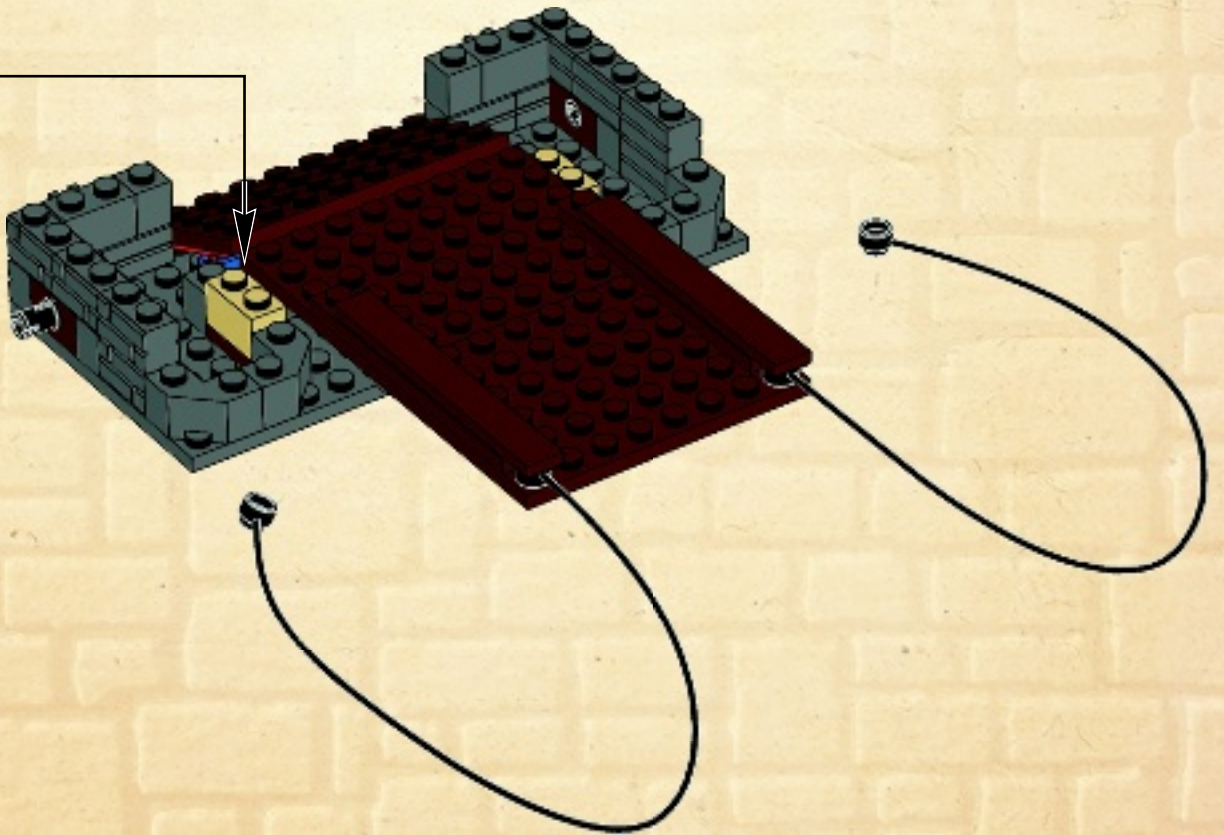





2x



4x

9

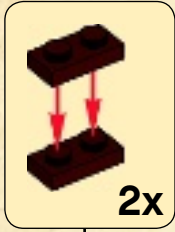

2x

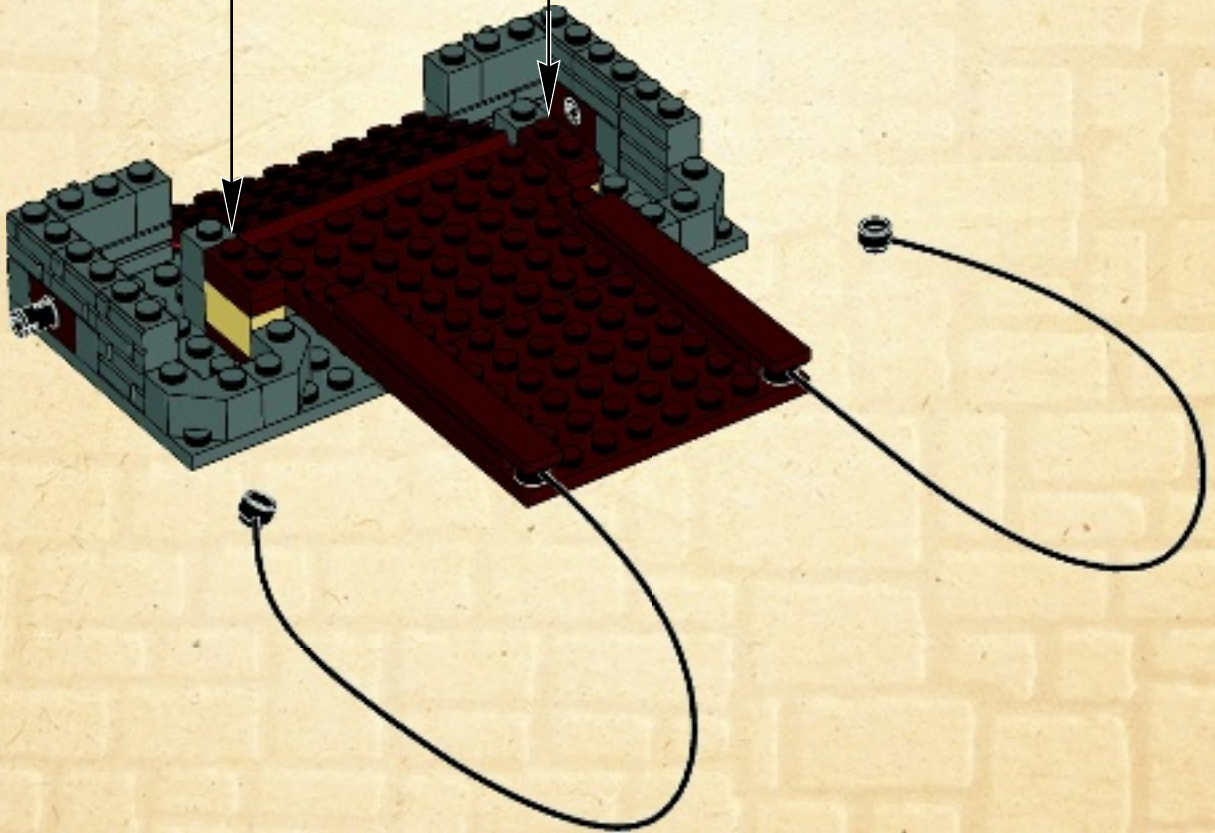



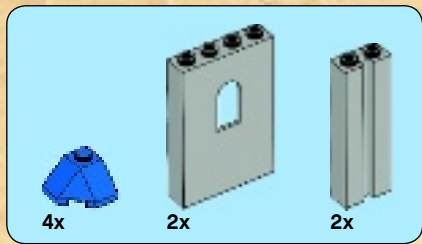

10

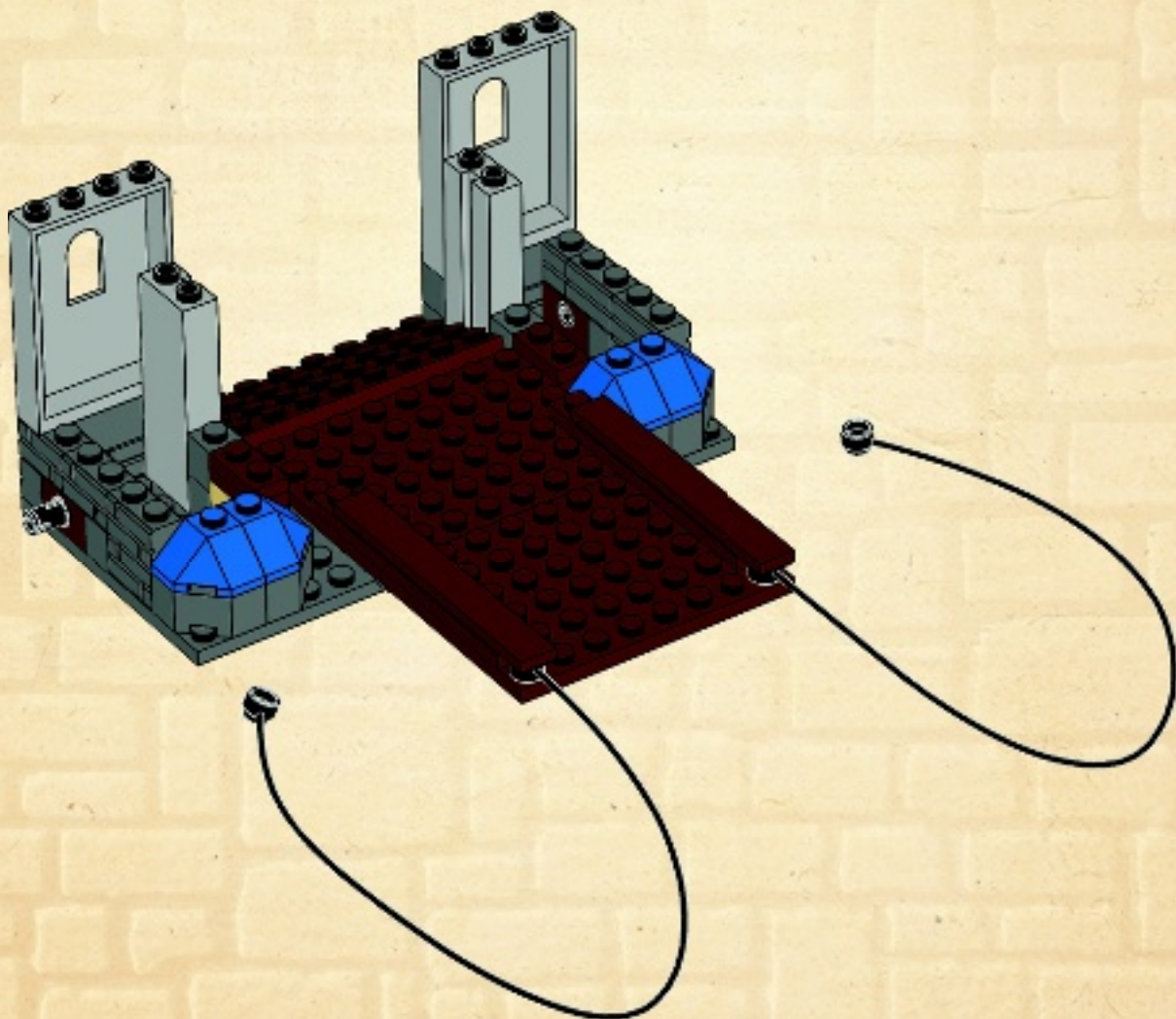



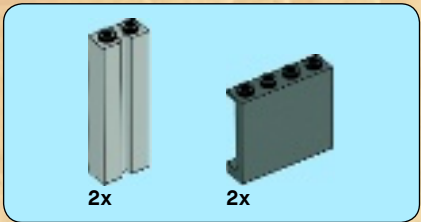

11

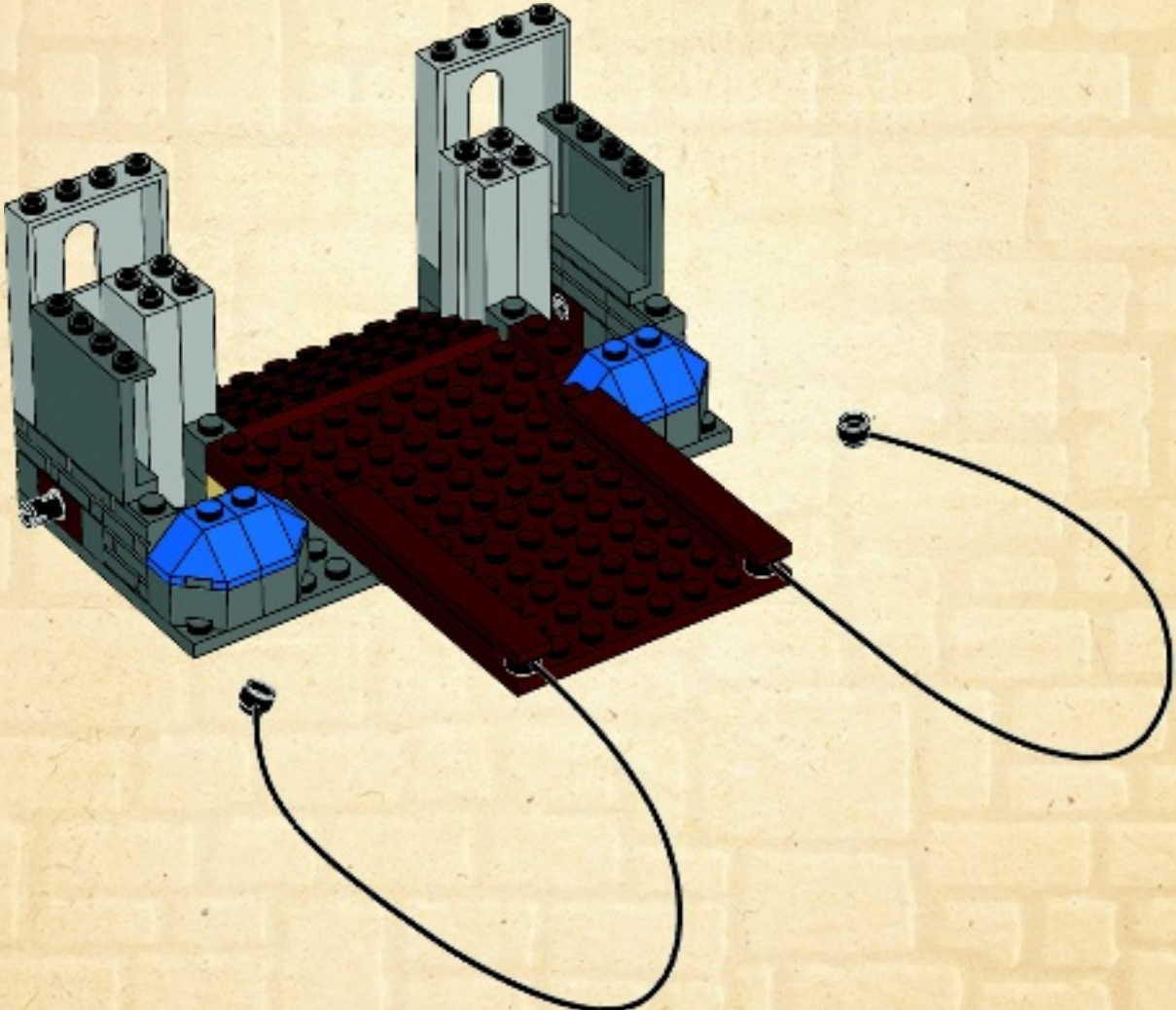





# 12

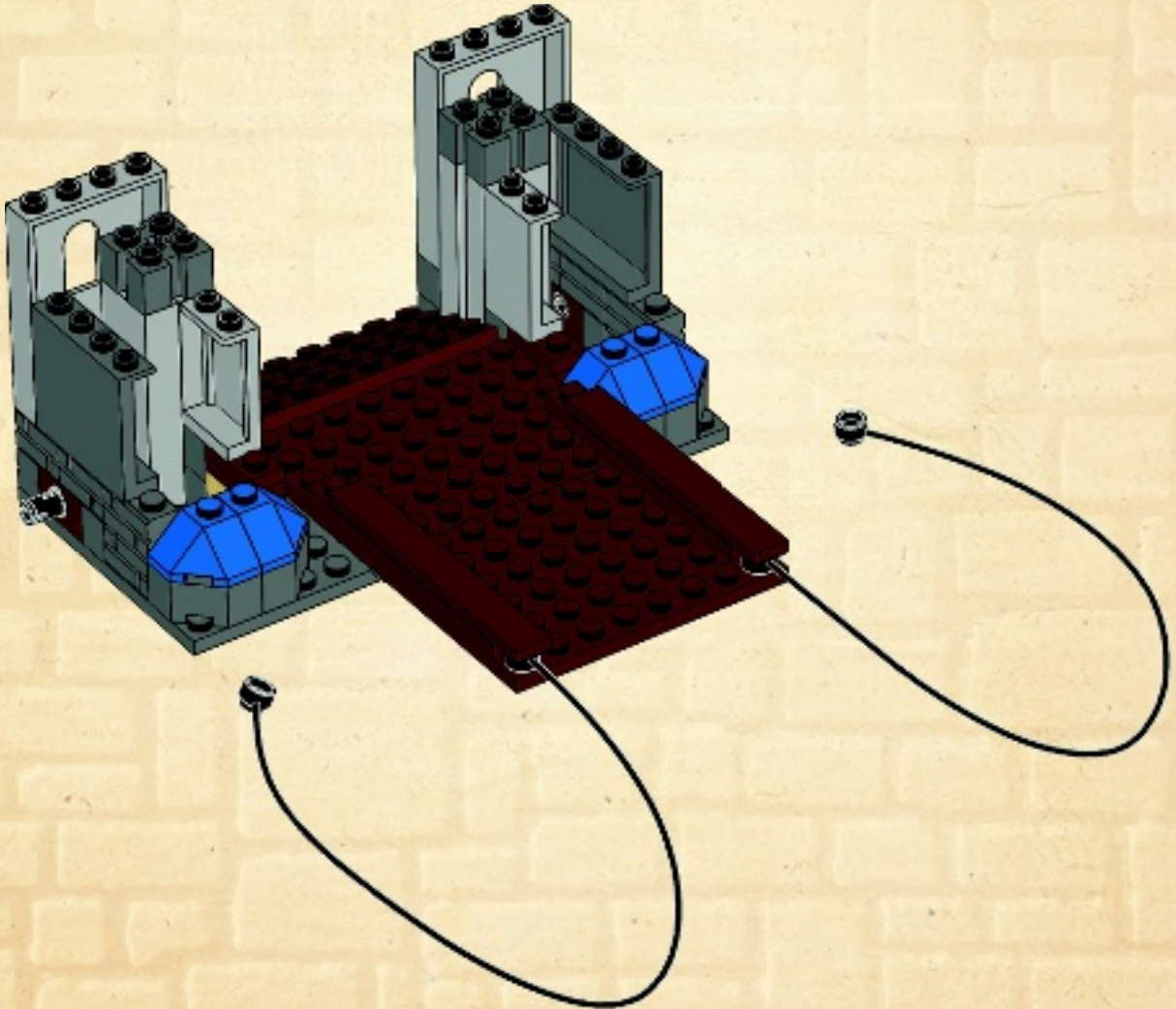





# 13

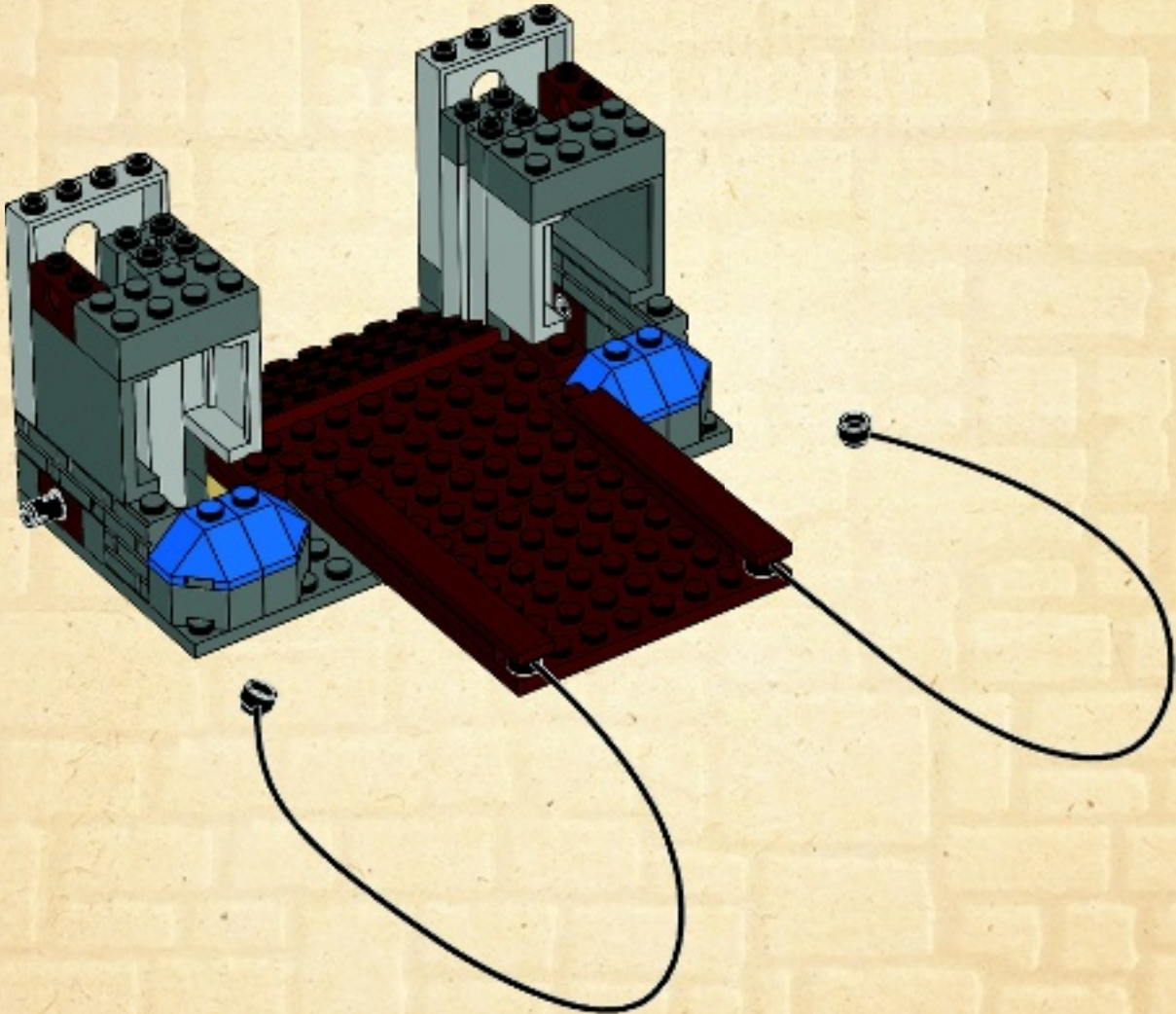



2x 4x 2x

# 14

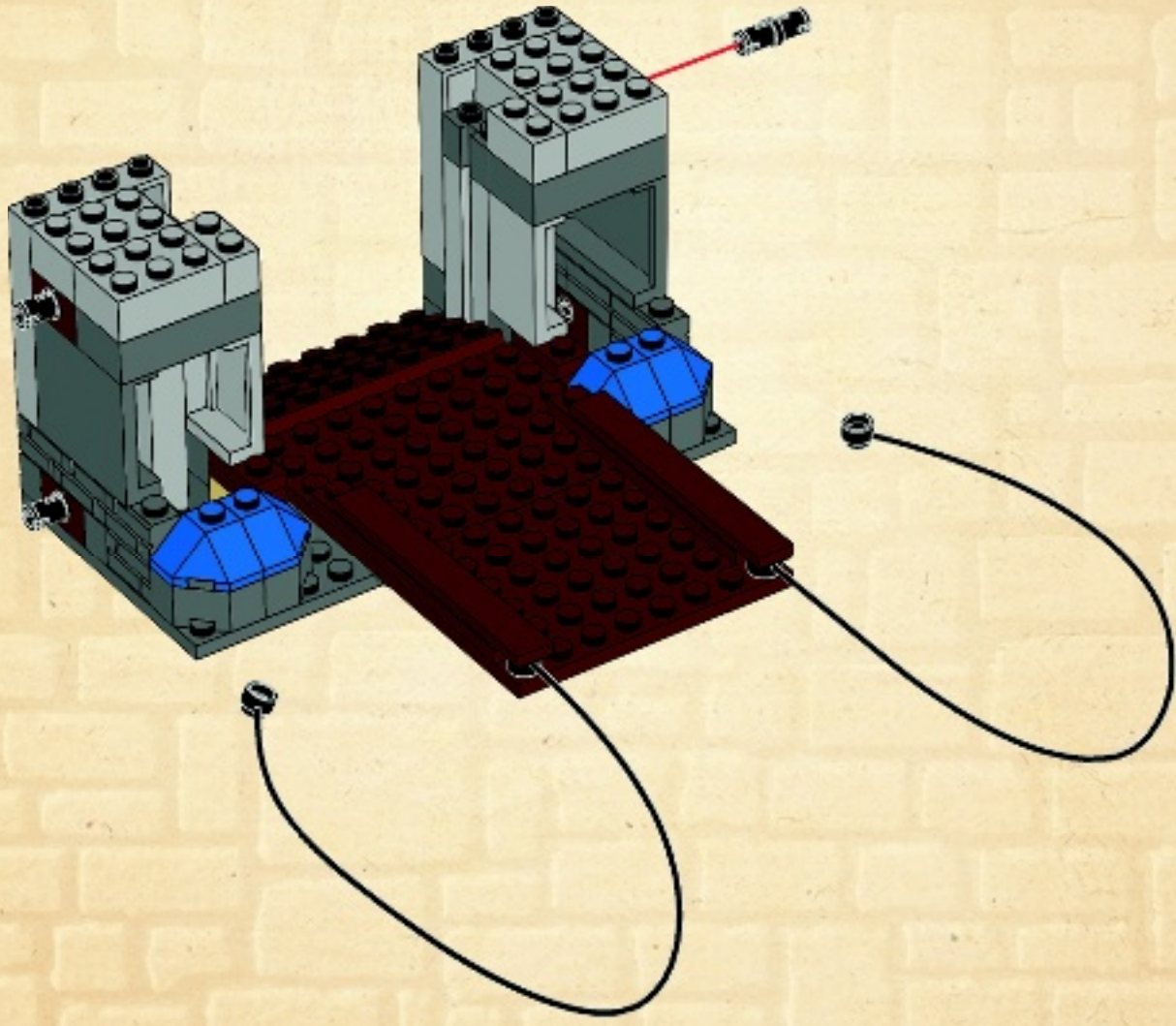



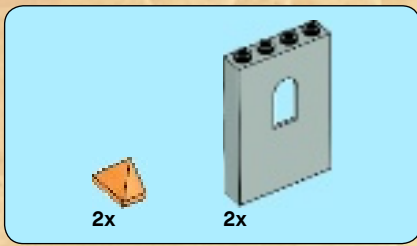

15

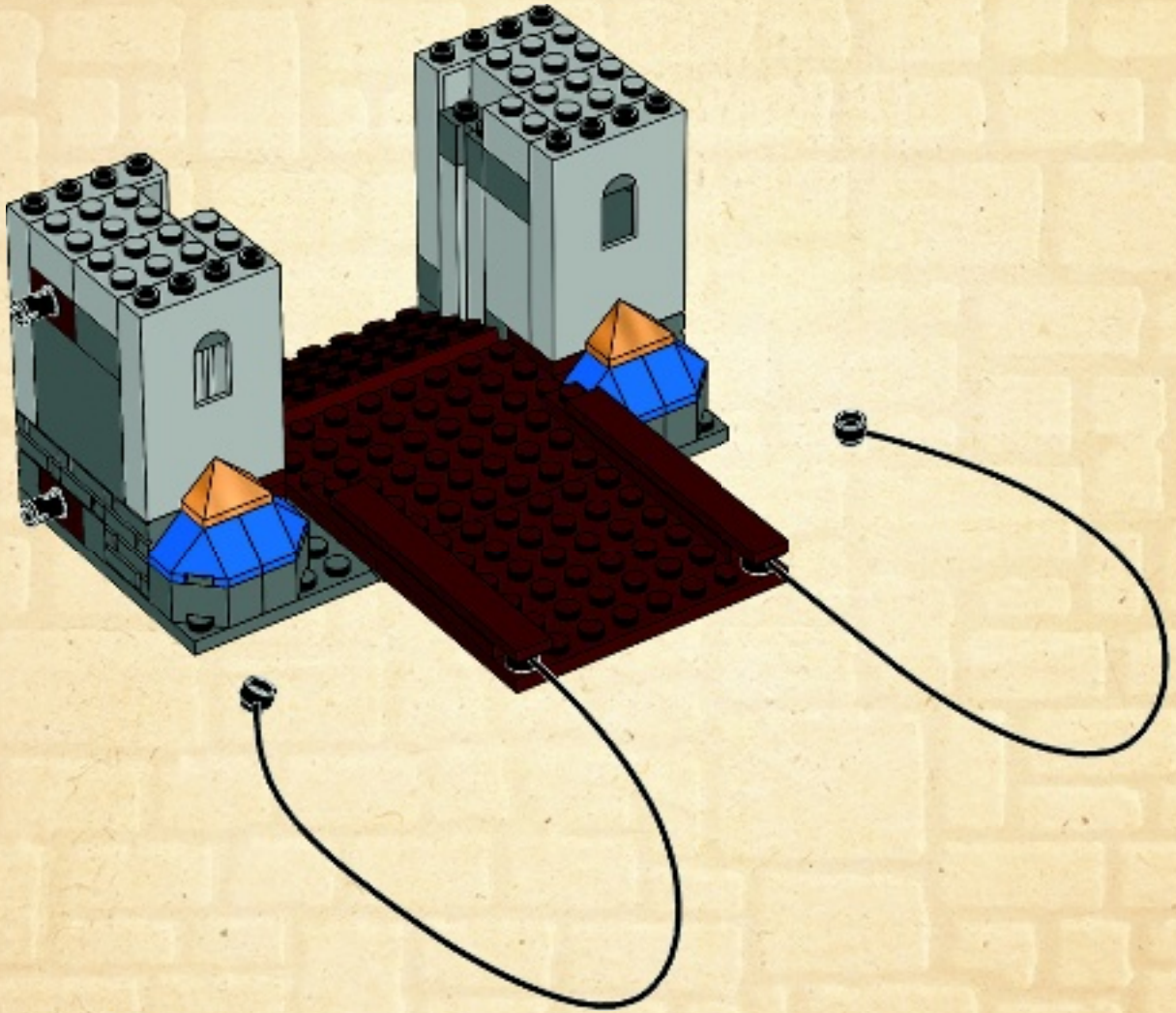



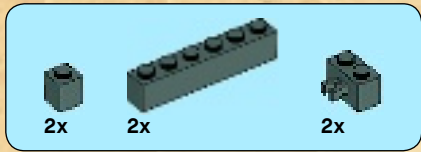

# 16

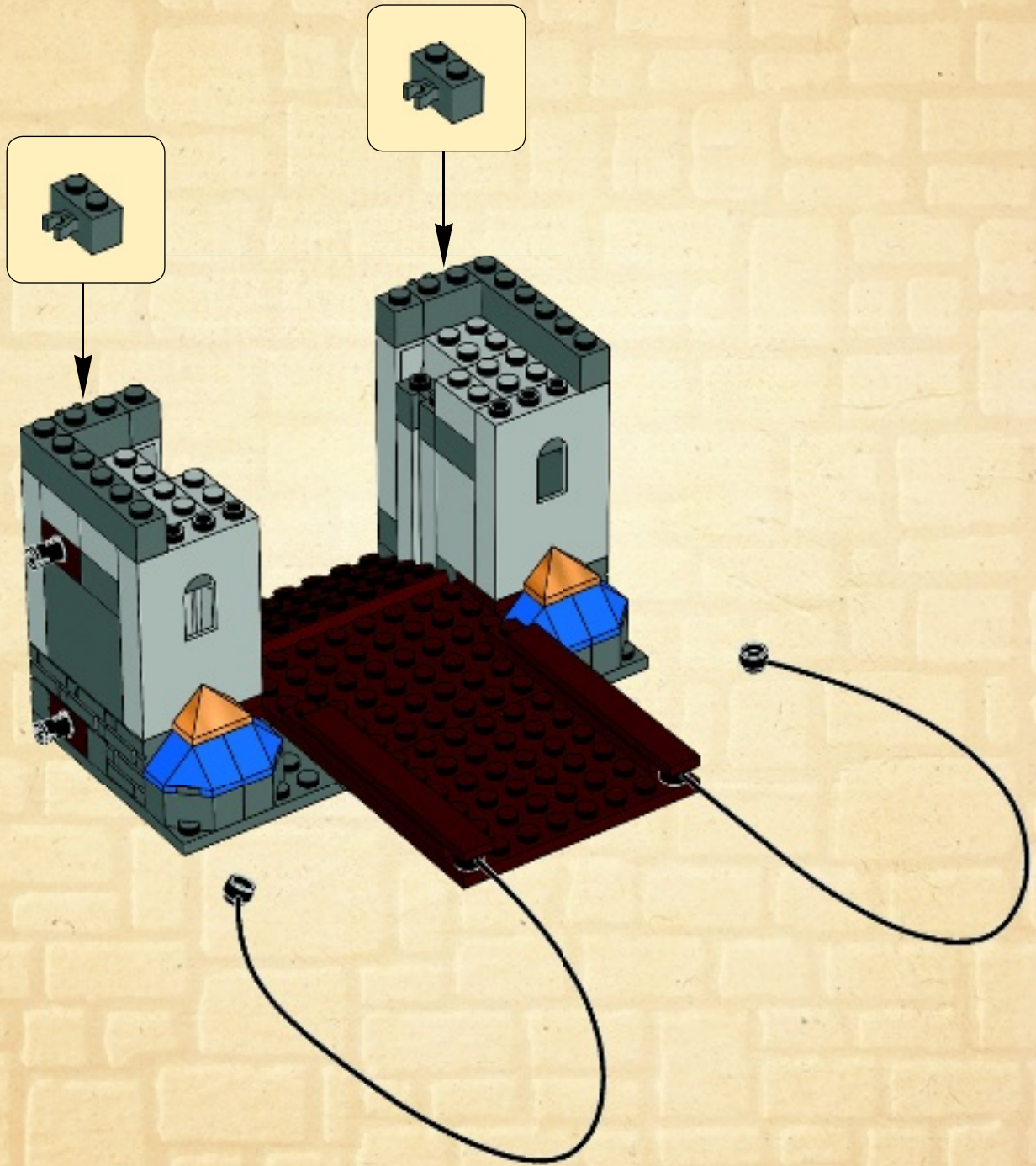



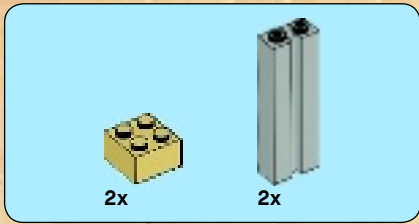

17

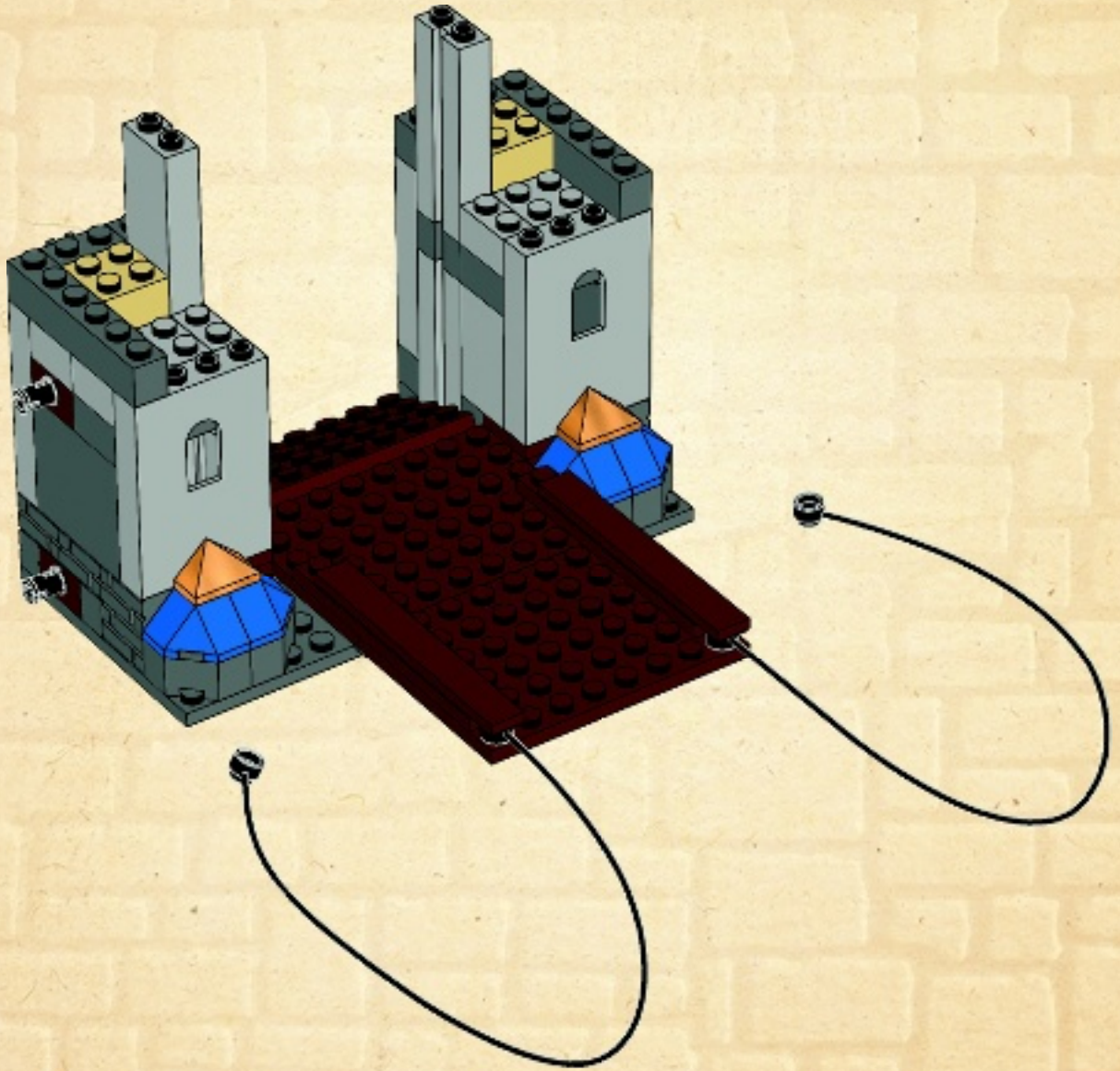



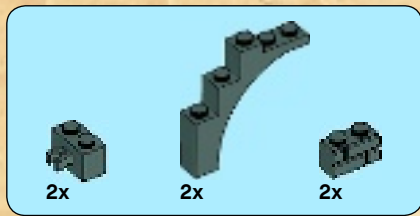

18

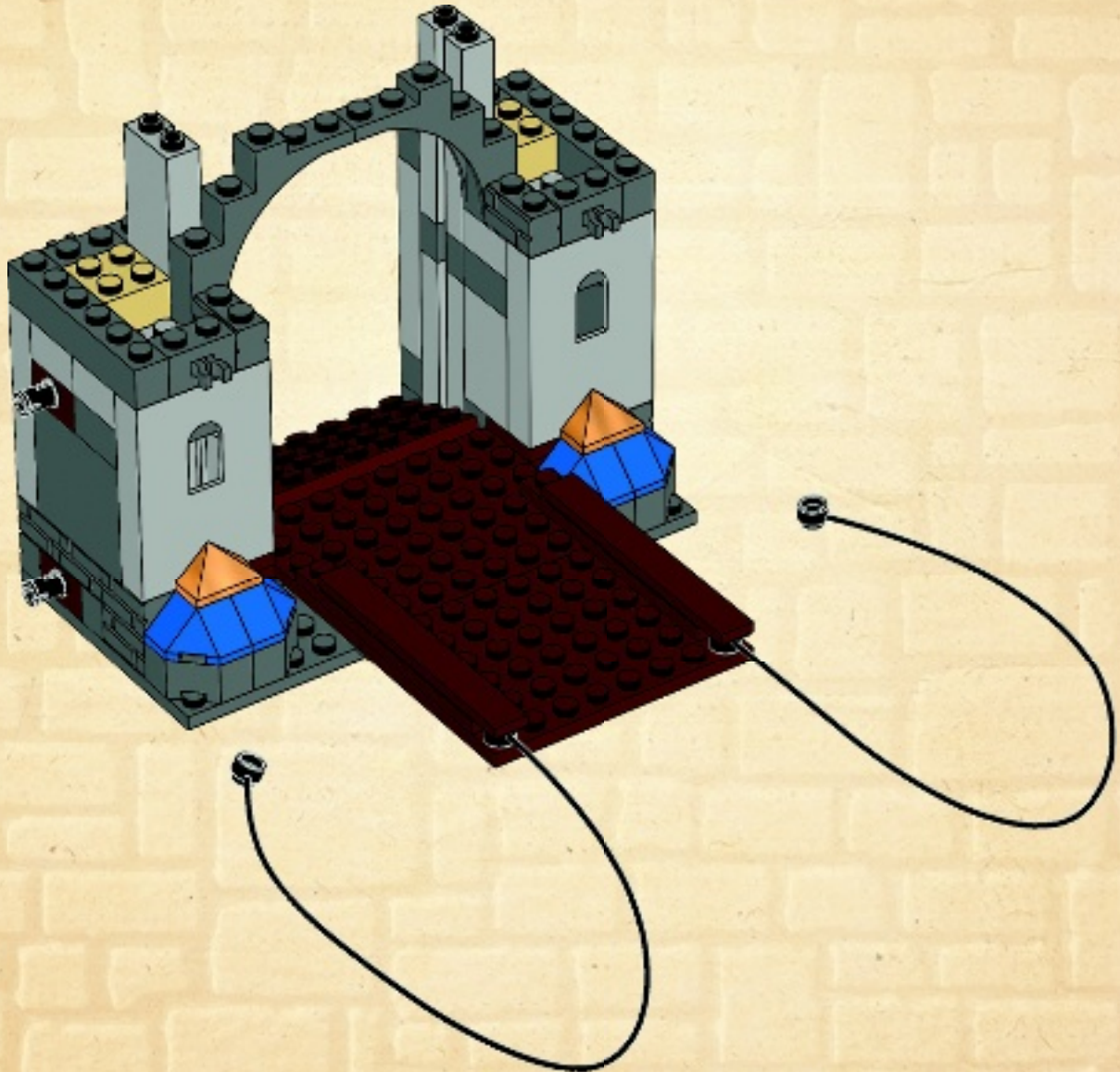





19

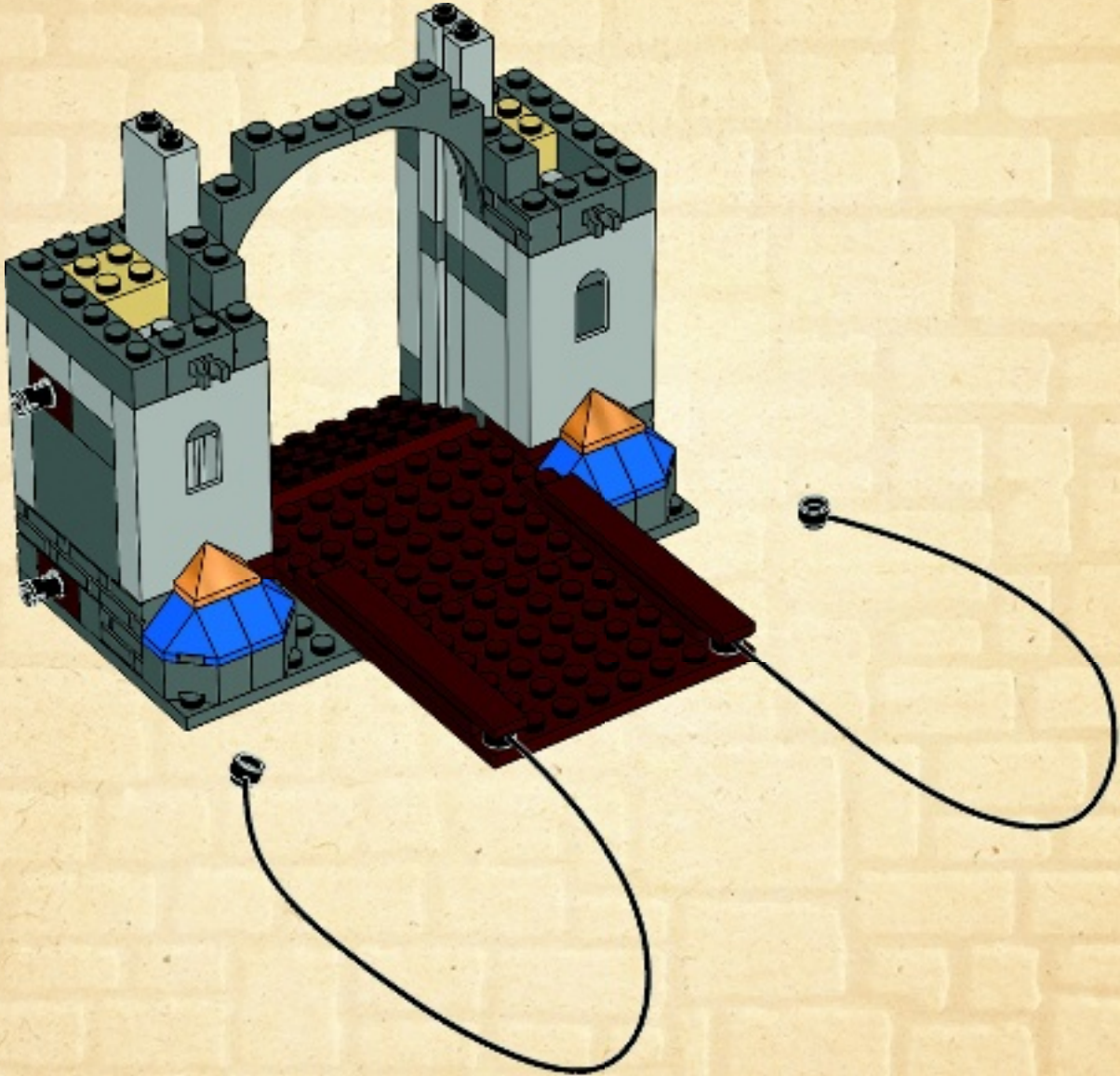





2x

20

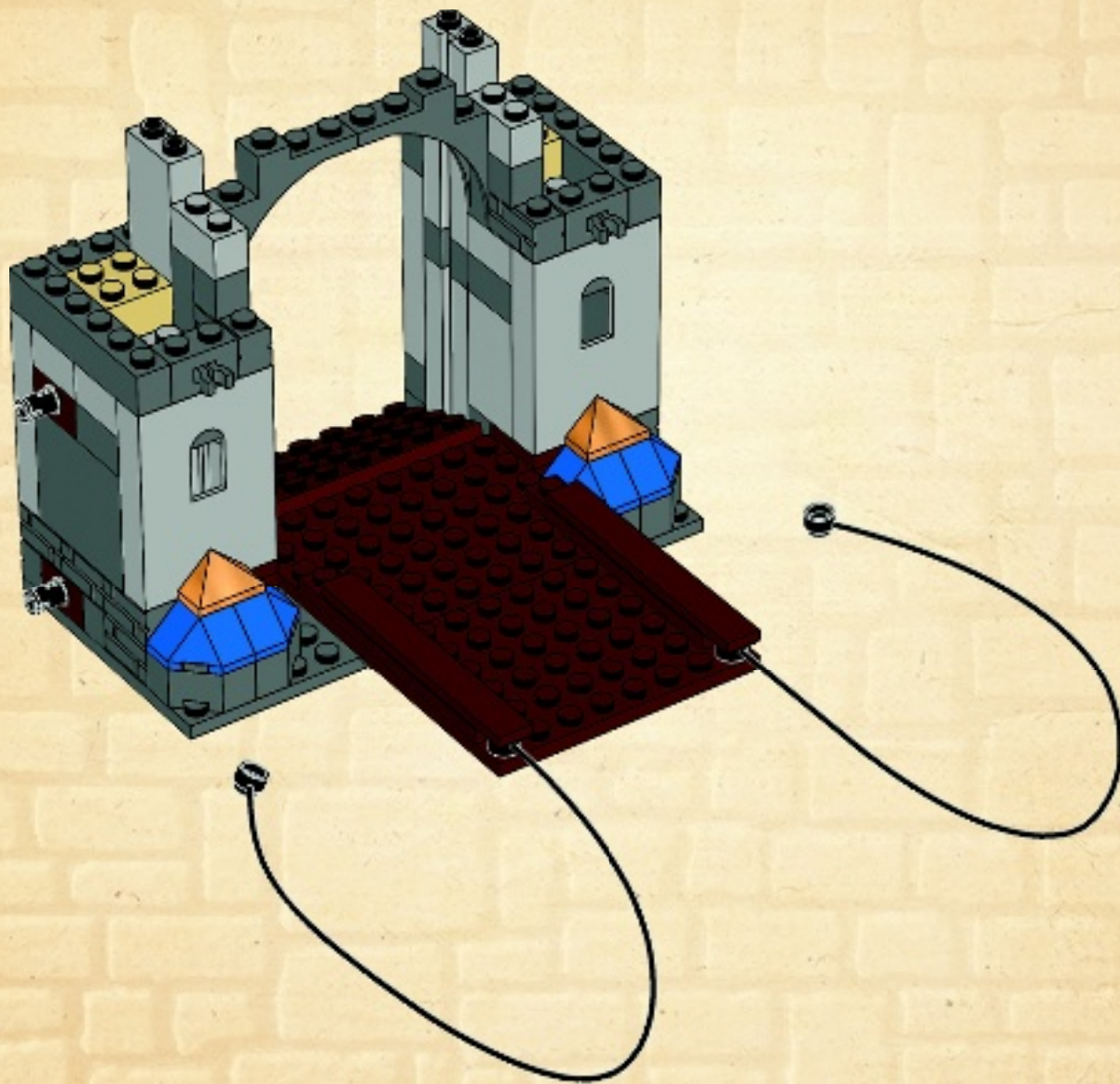





1x



2x

# 21

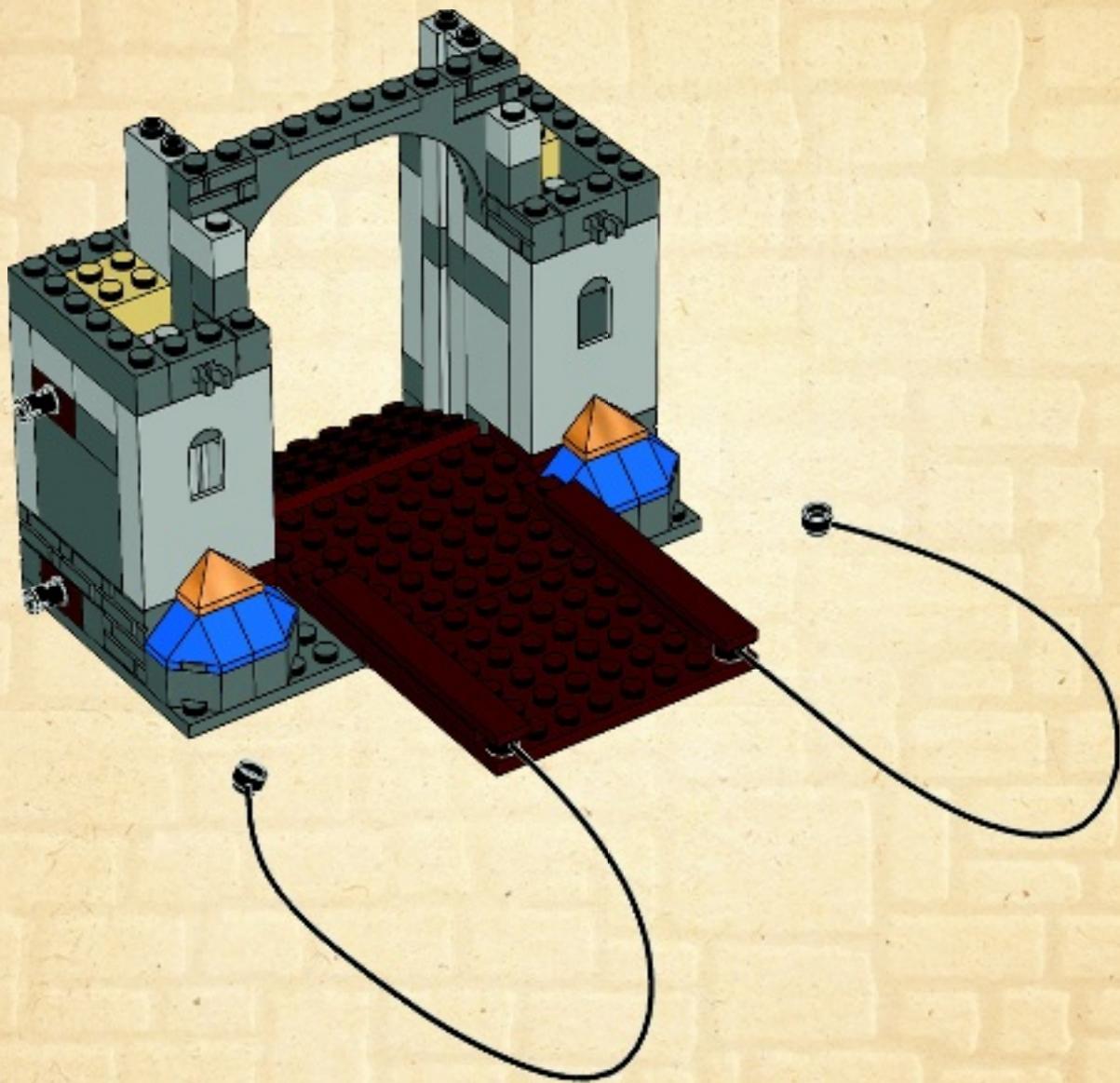



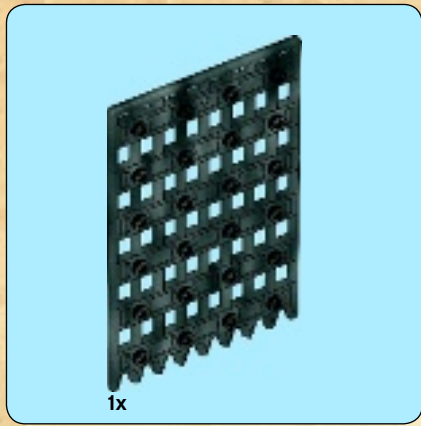

22

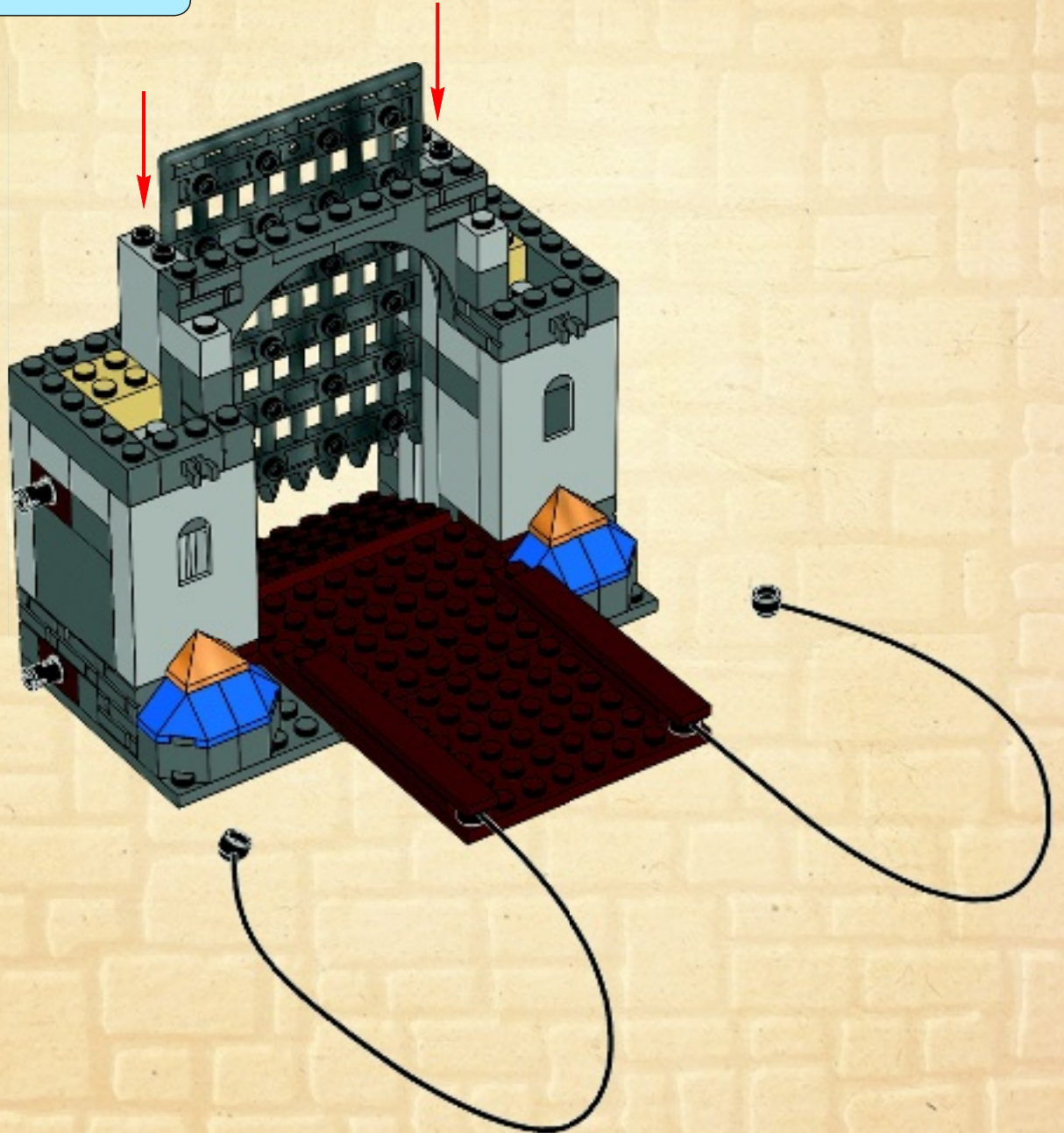



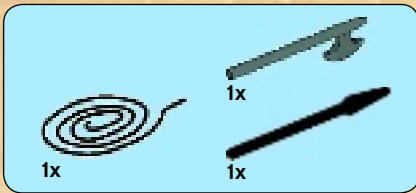

23

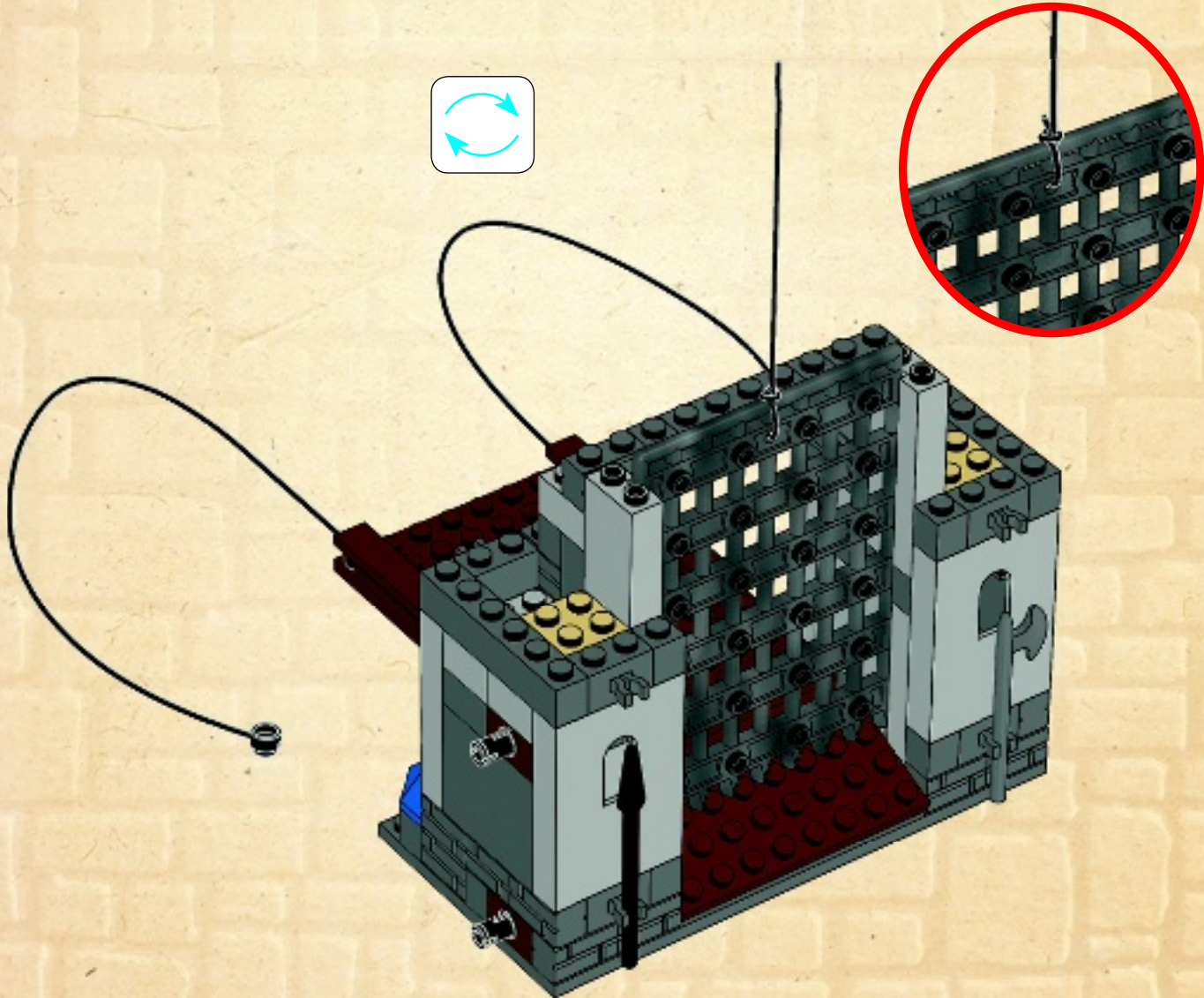
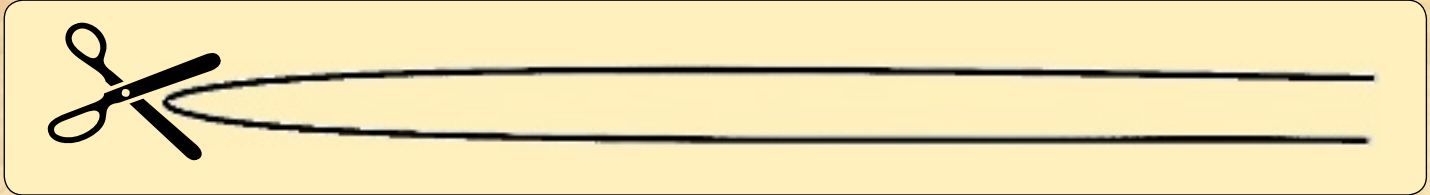





3

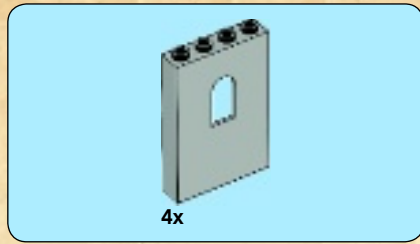
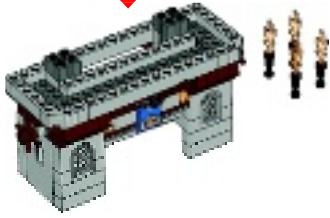

4x

24

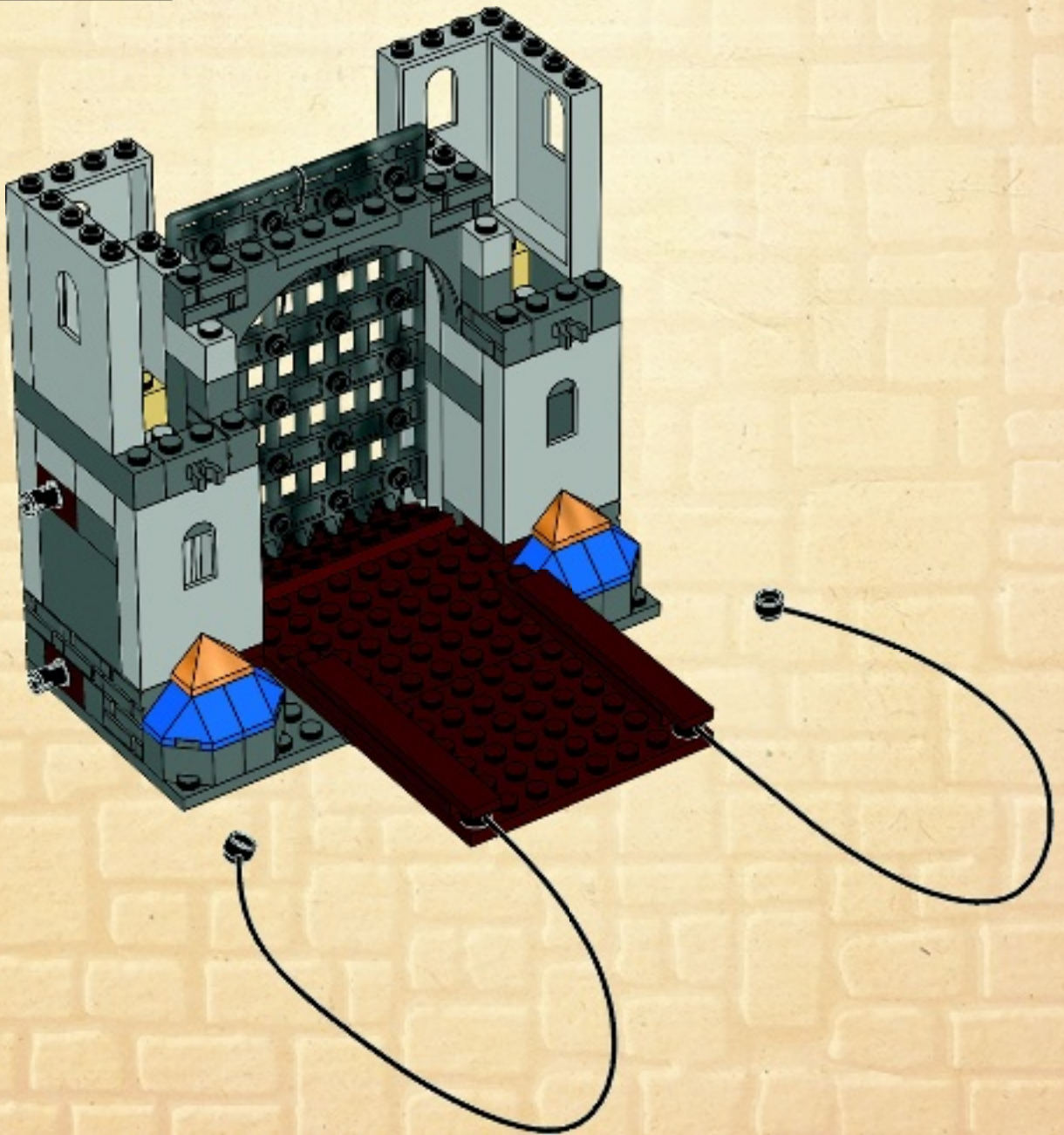
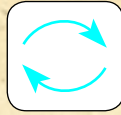





4x

# 25

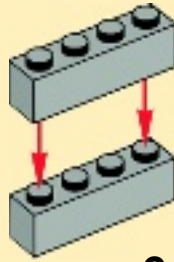

2x

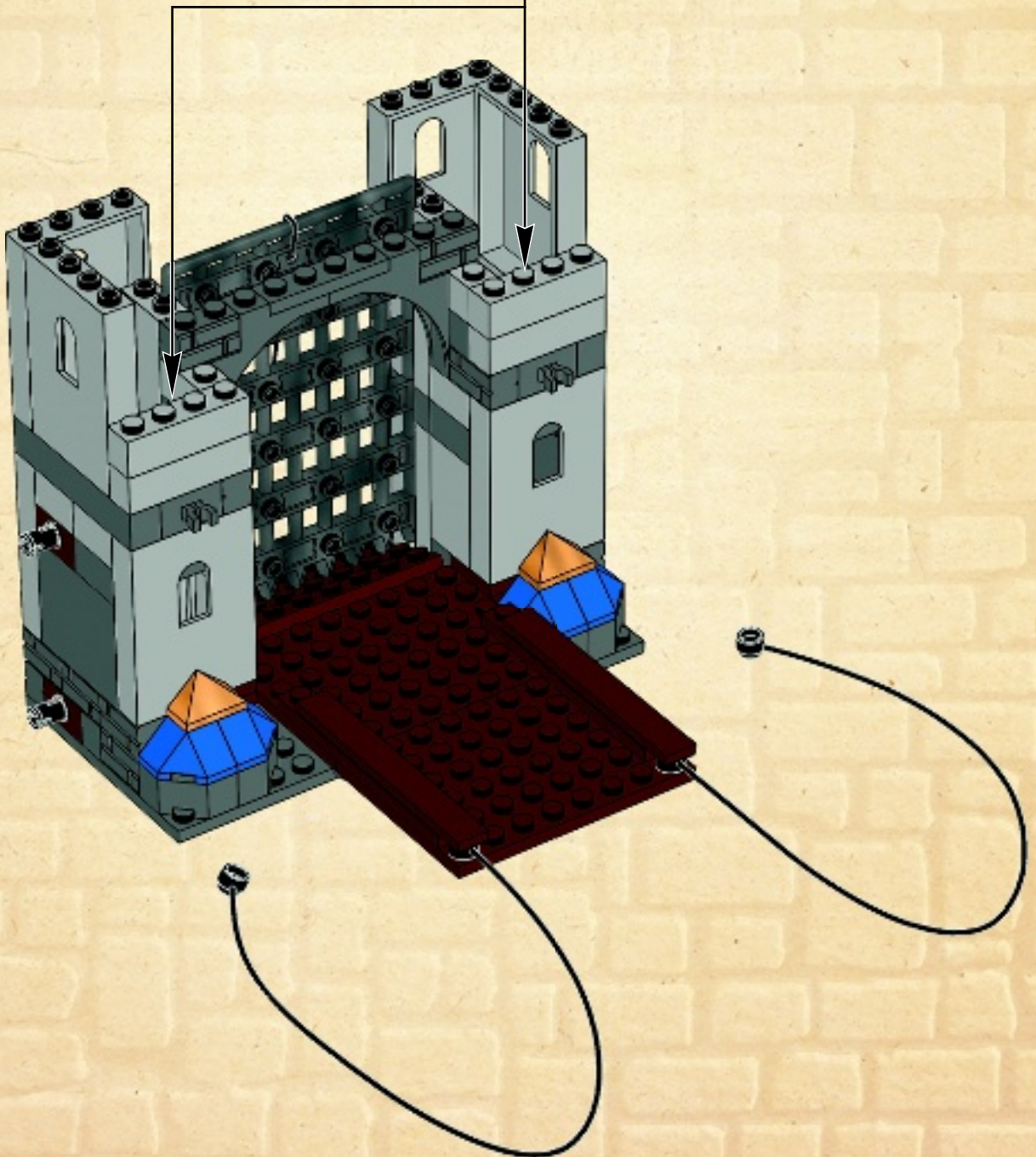





2x



2x

# 26

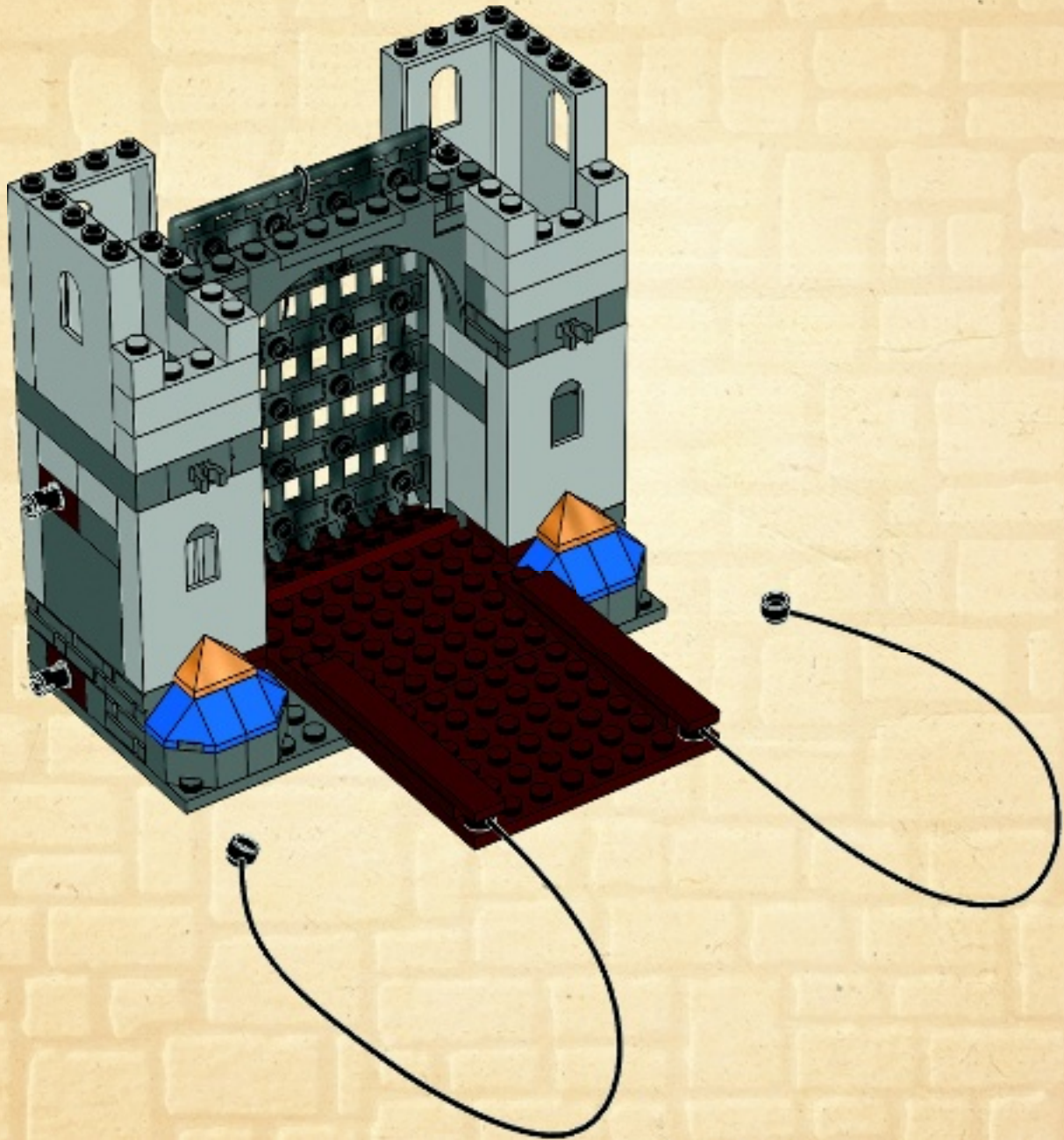



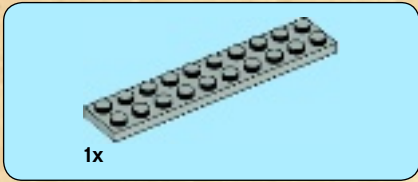
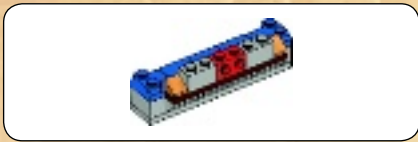

1x

1



2x

2

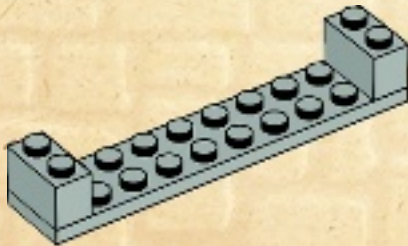

1x

2x

3

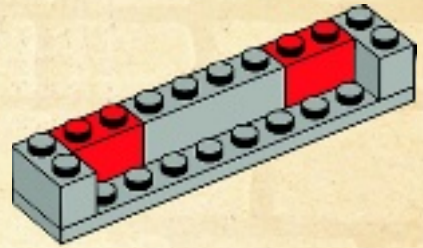

4x

4

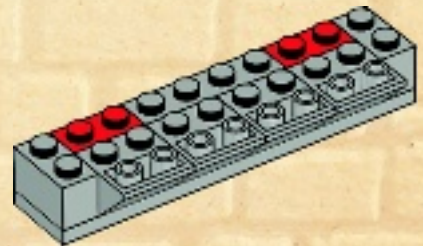



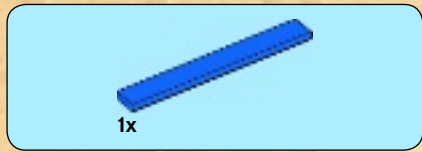

5

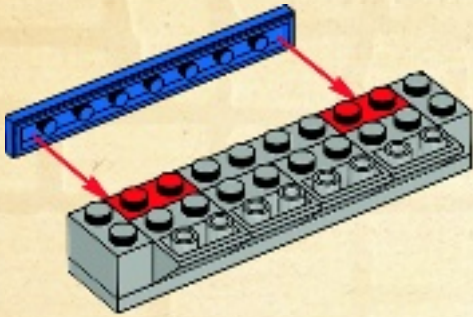

6

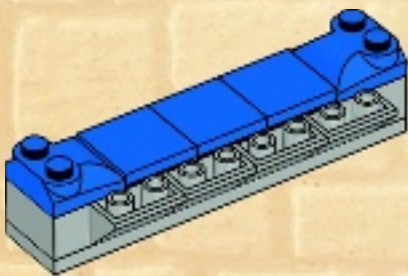

7

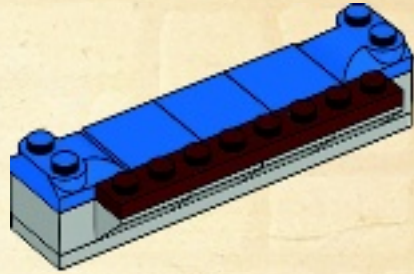

8

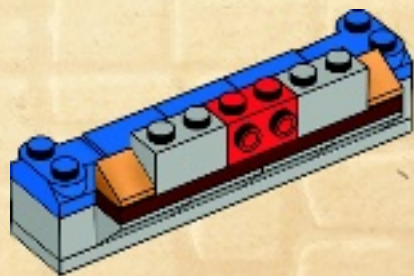



27

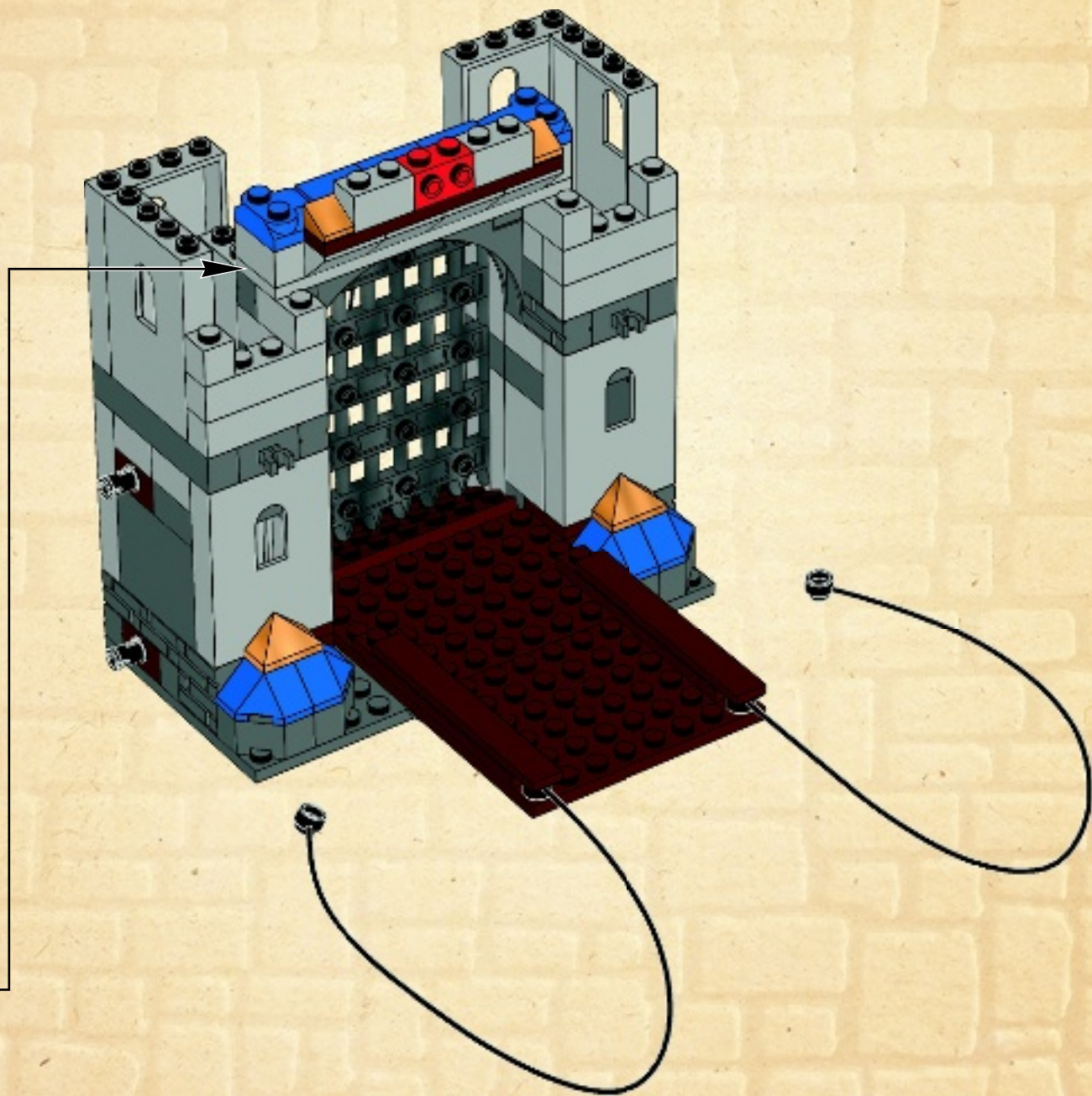



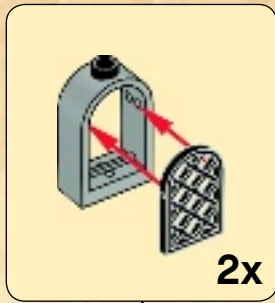
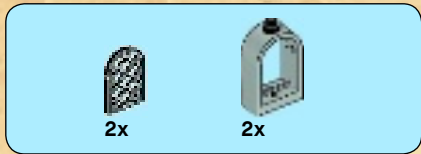

28

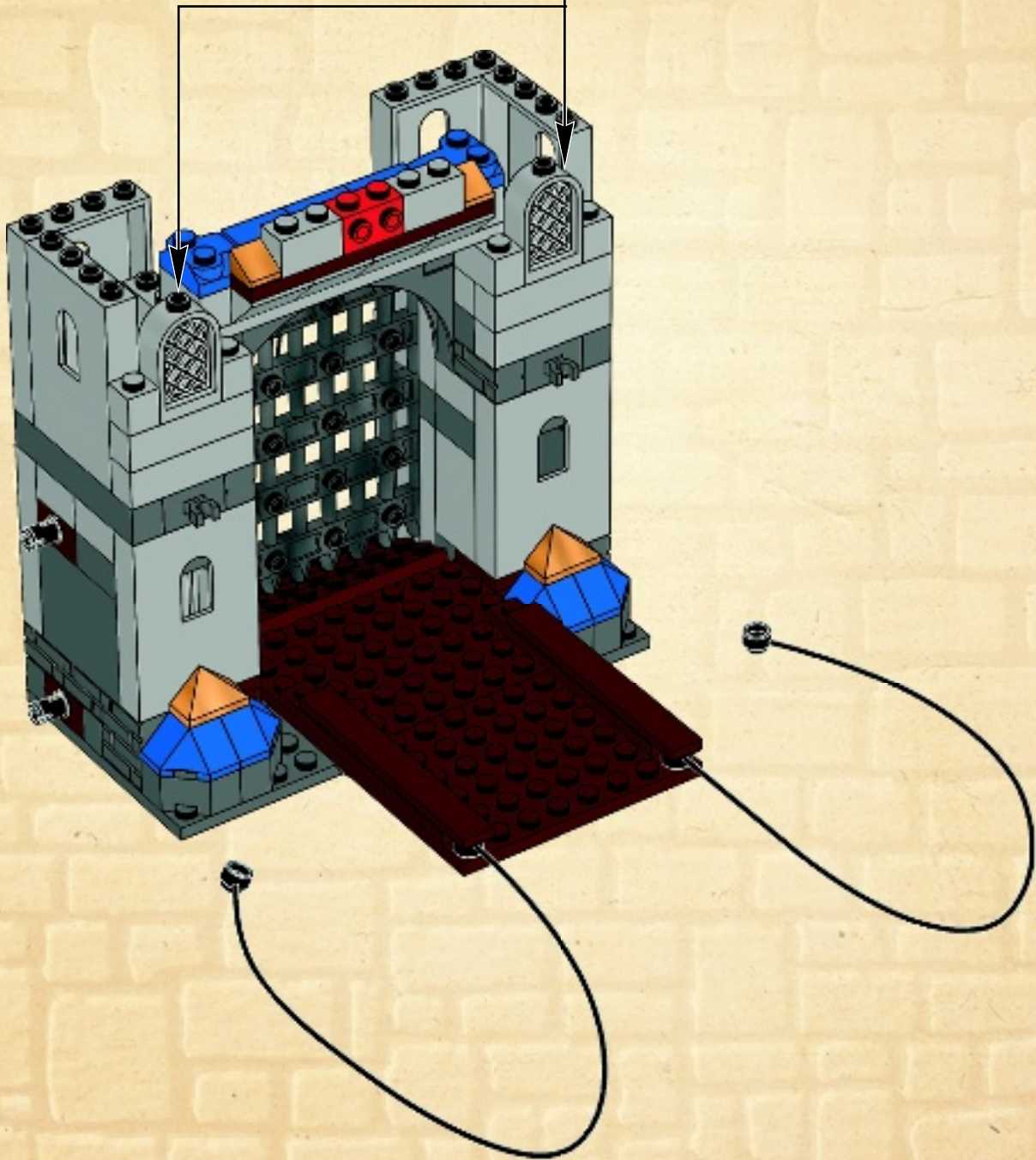





2x

# 29

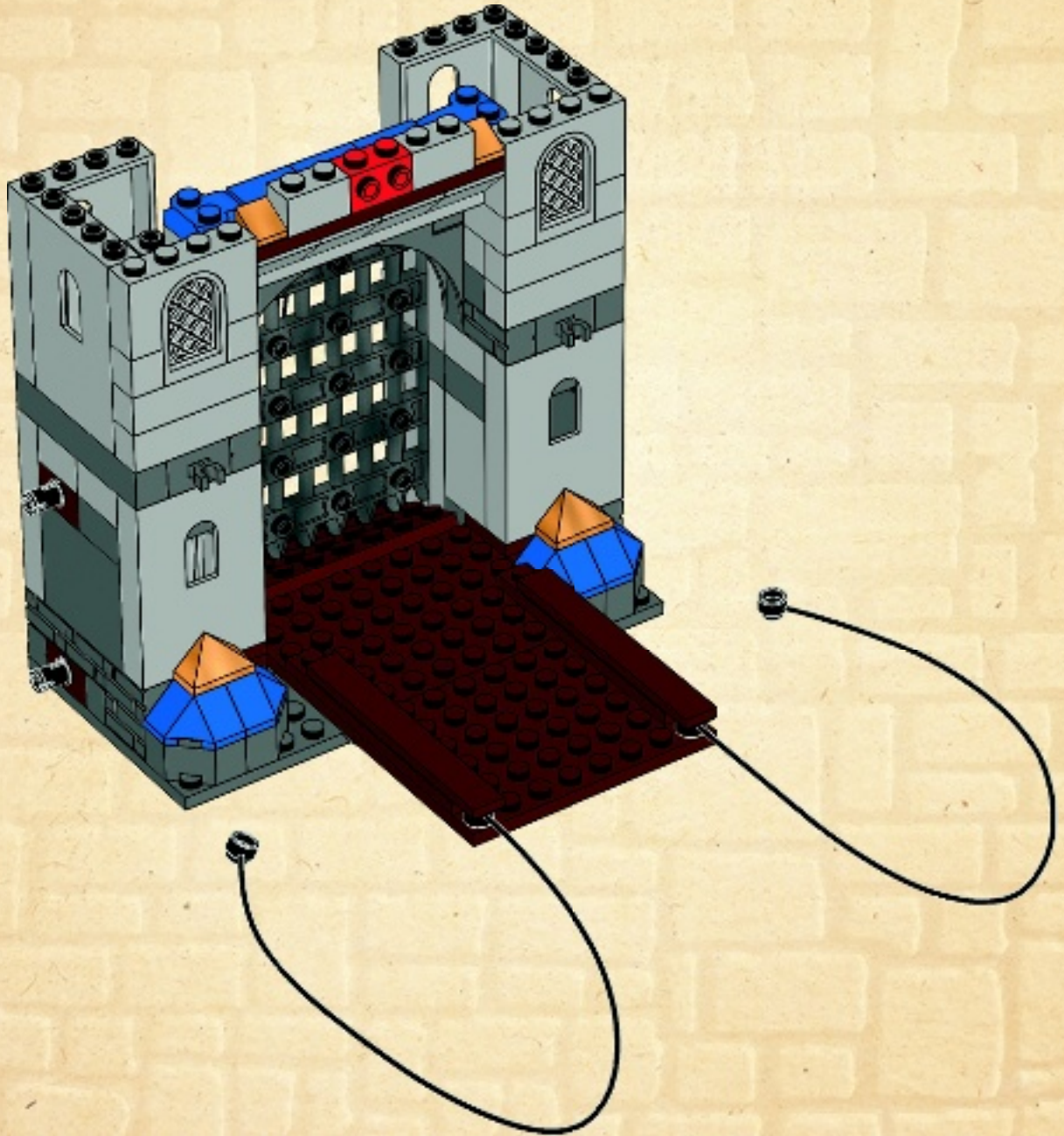





# 30

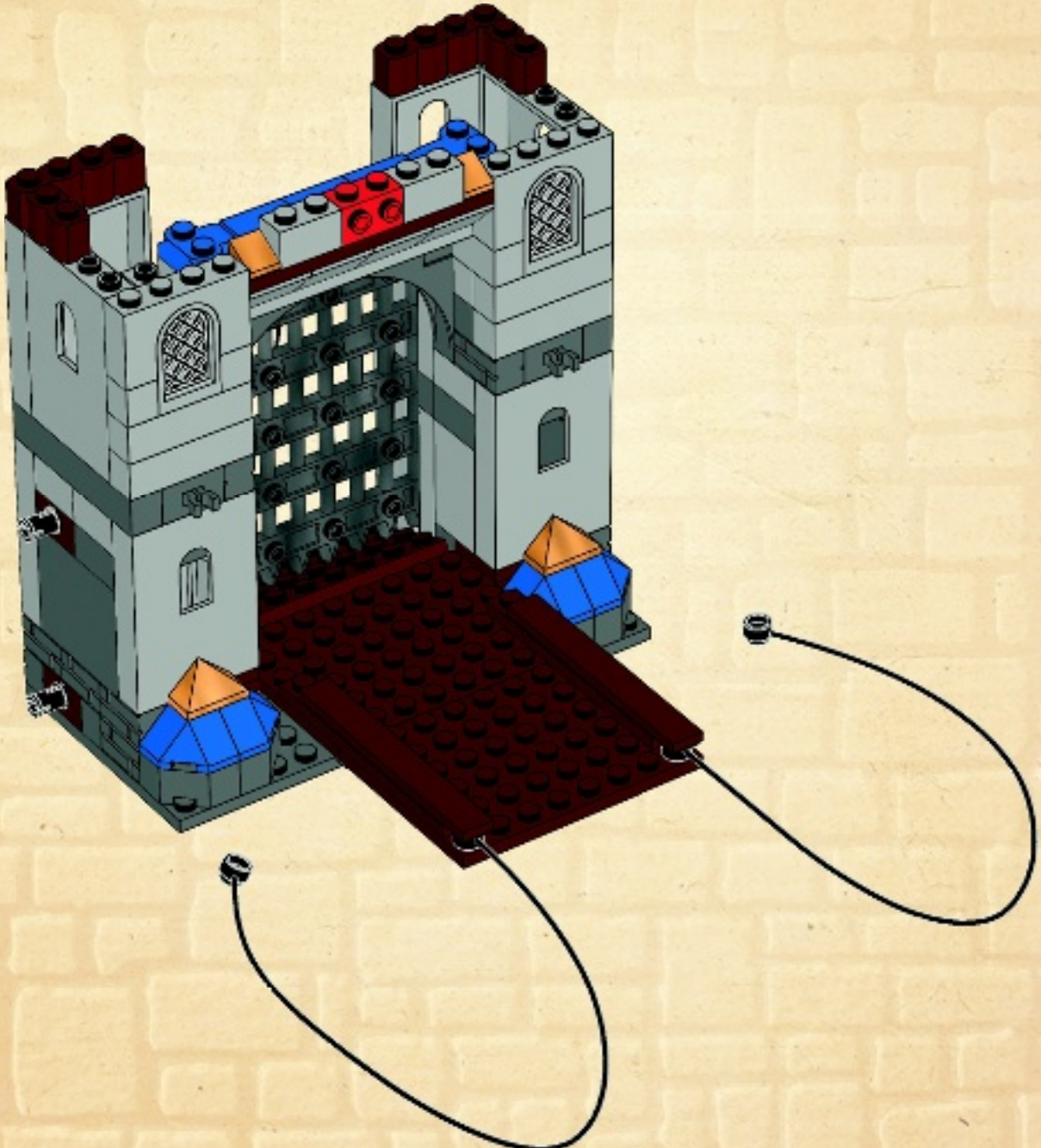



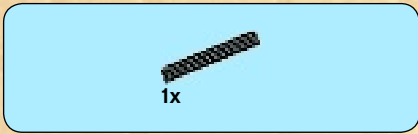

1

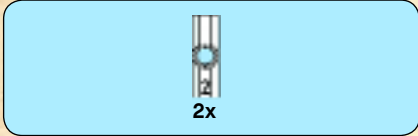
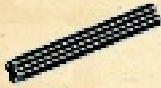

2

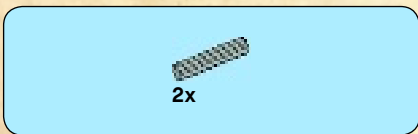
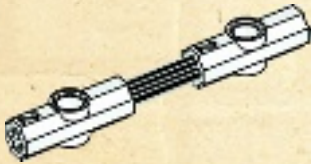

3

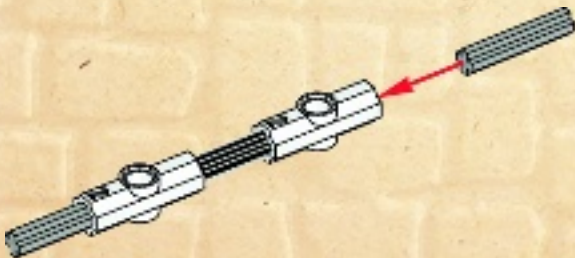

4



5

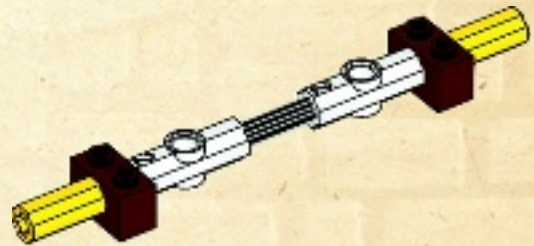





2x

6

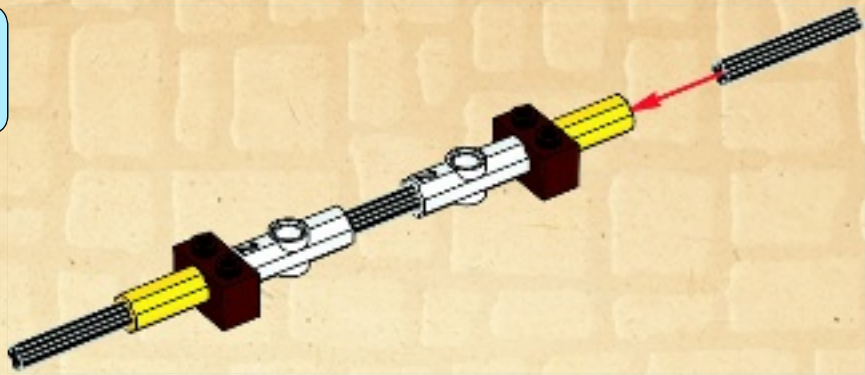

2x

7

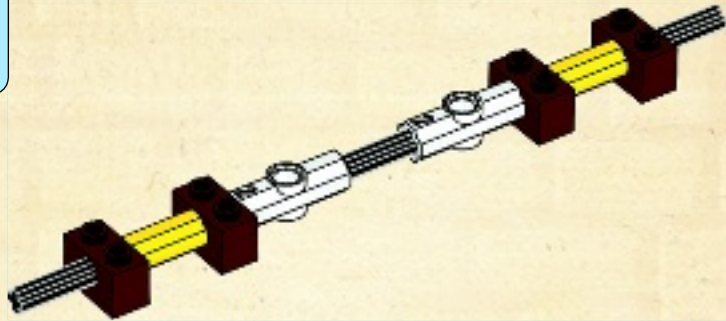

2x

8

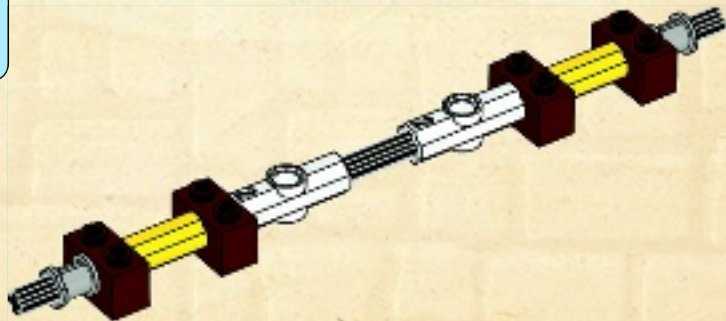

2x

9

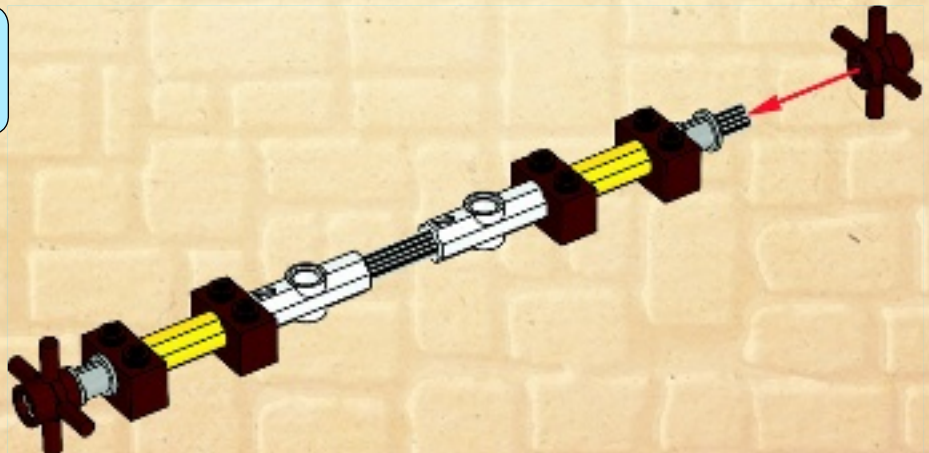



31

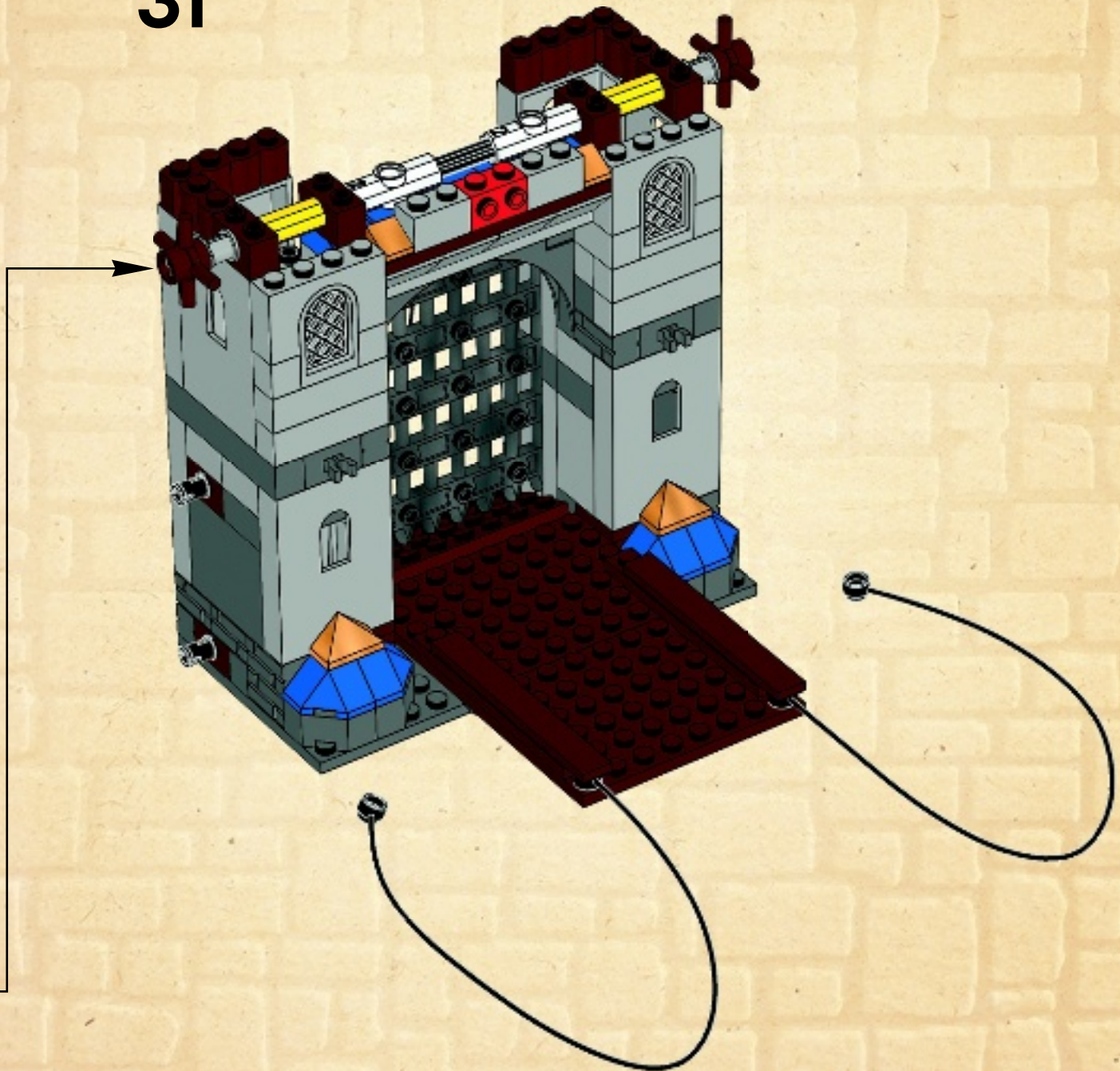



32

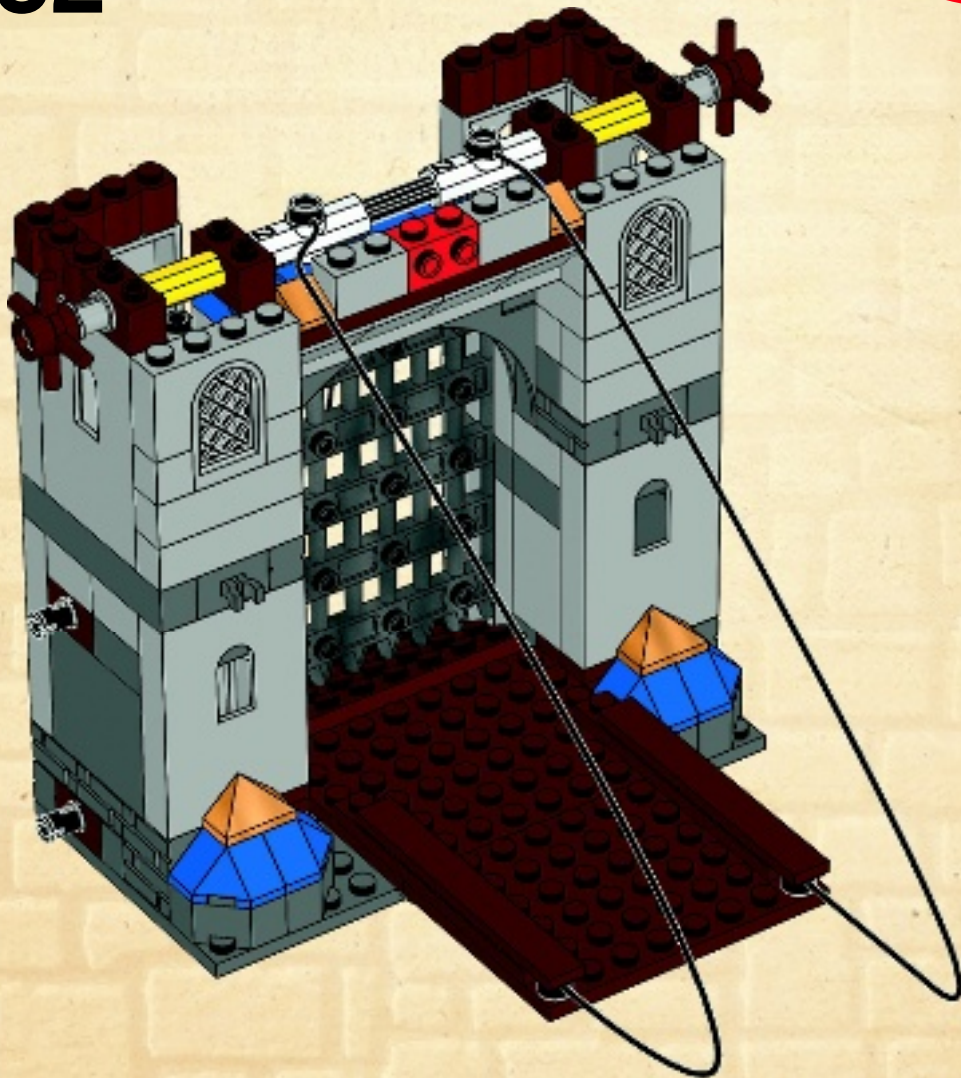





# 33

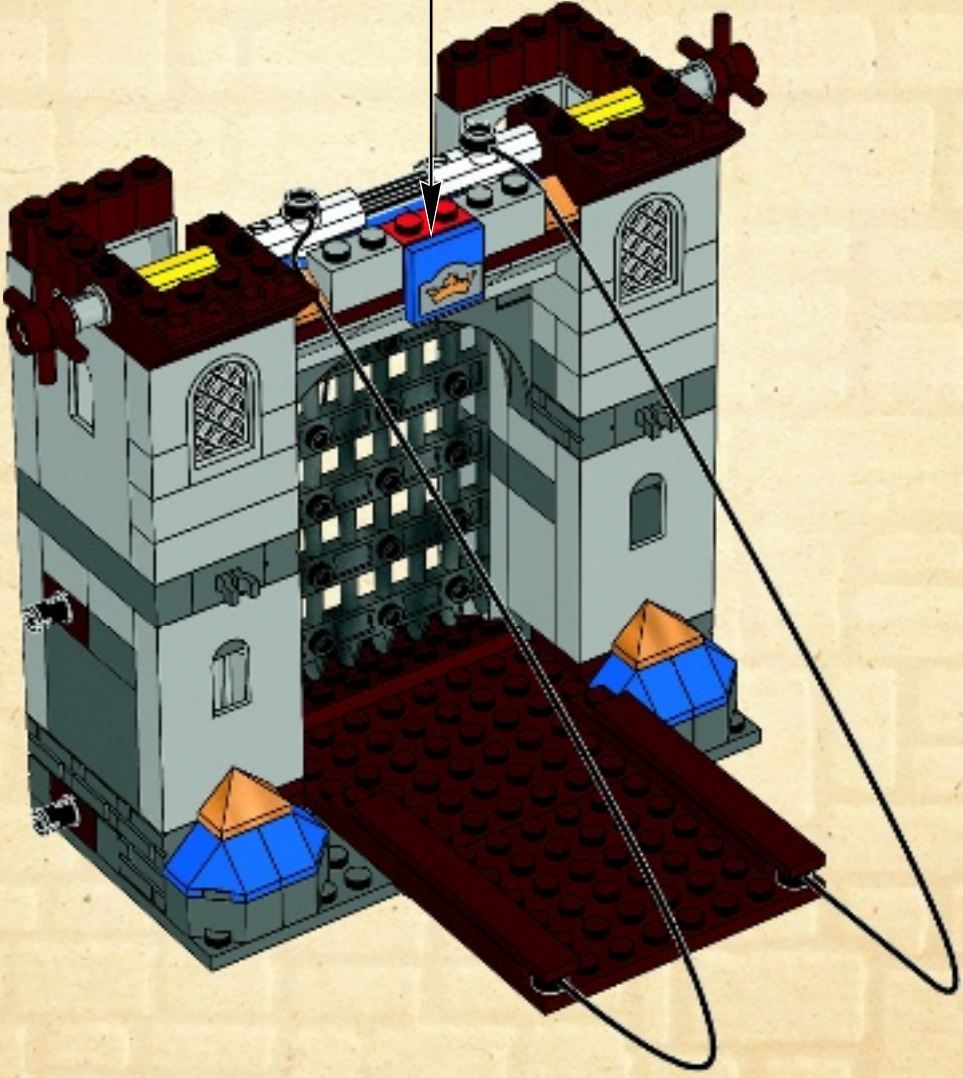
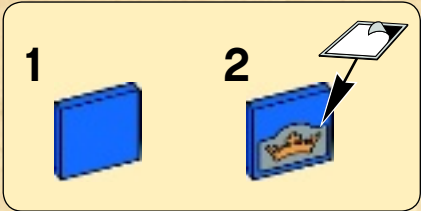





# 34

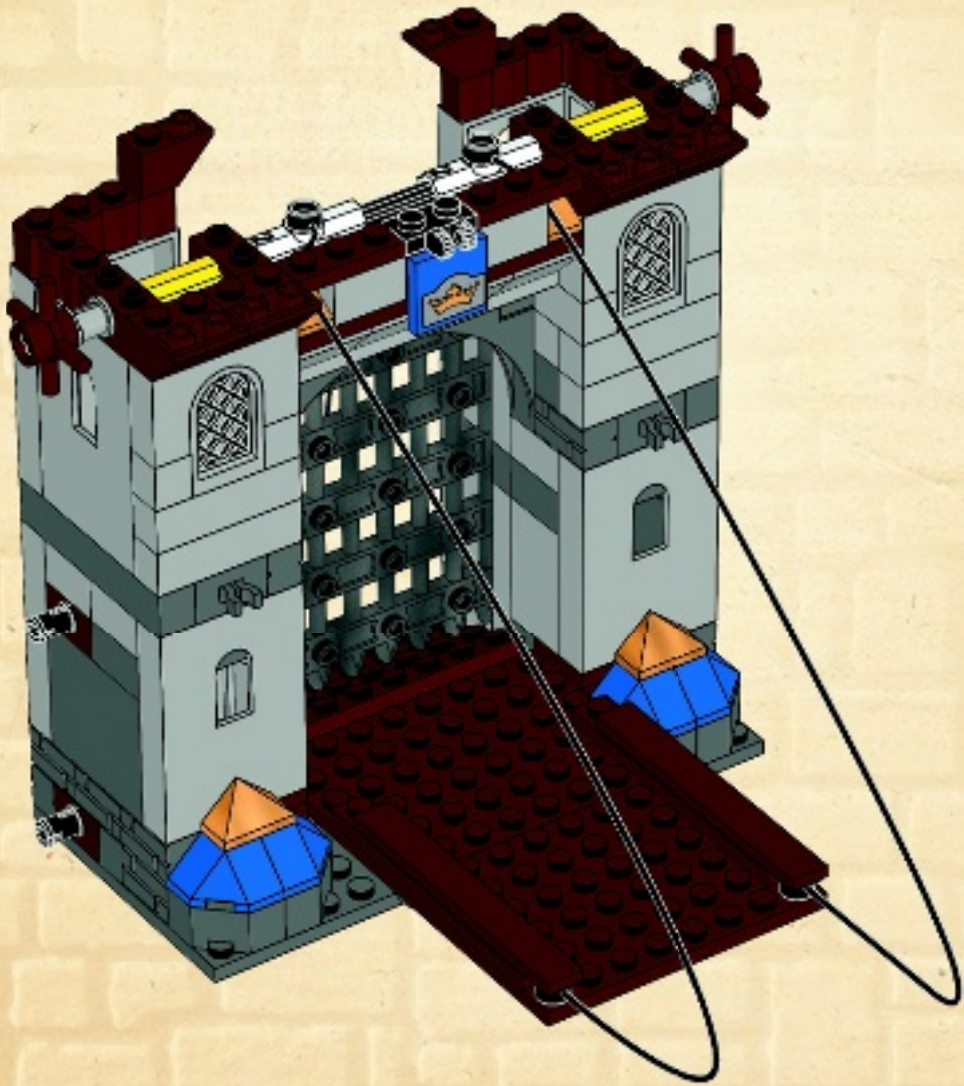



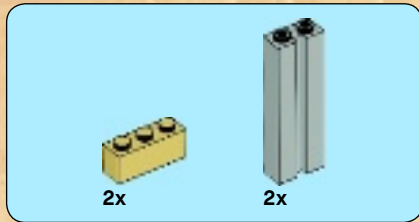

35

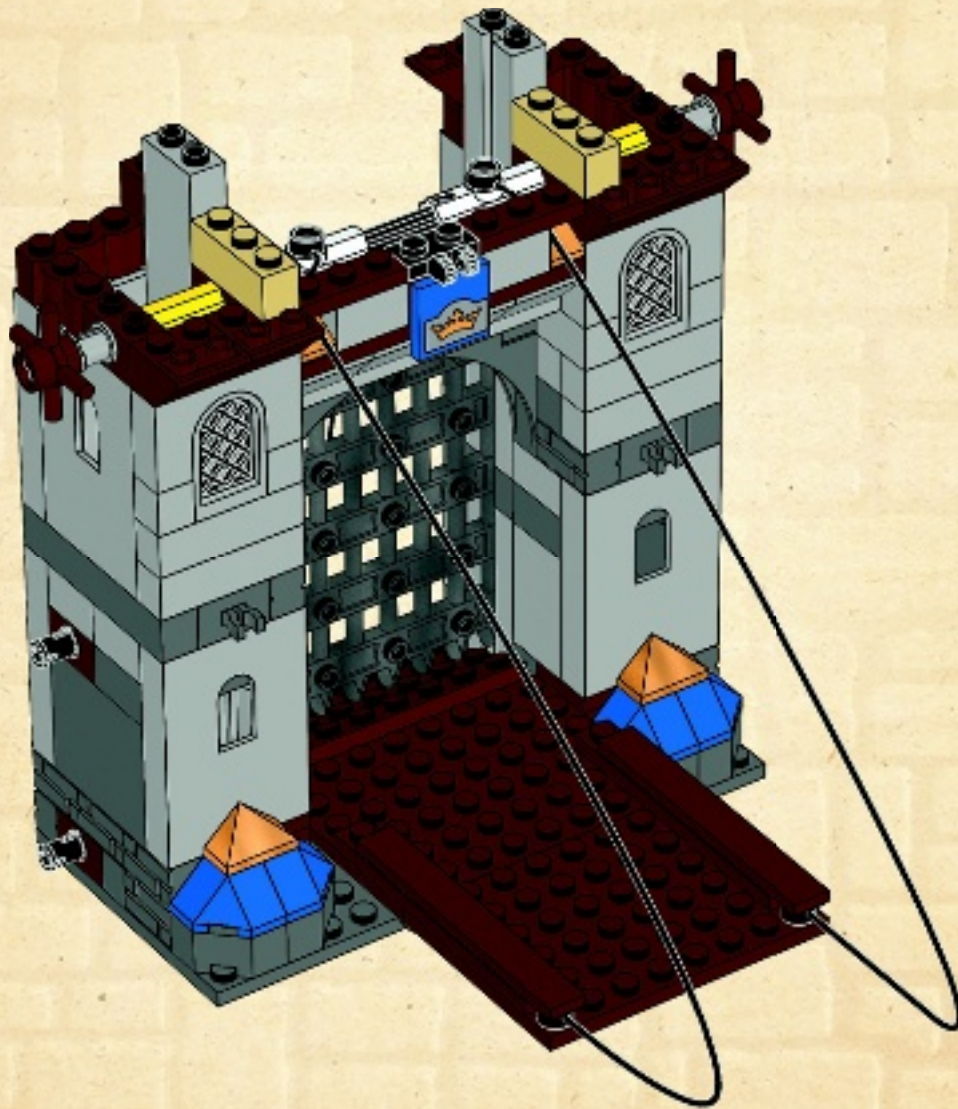



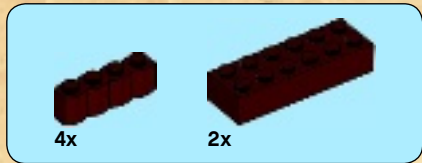

36

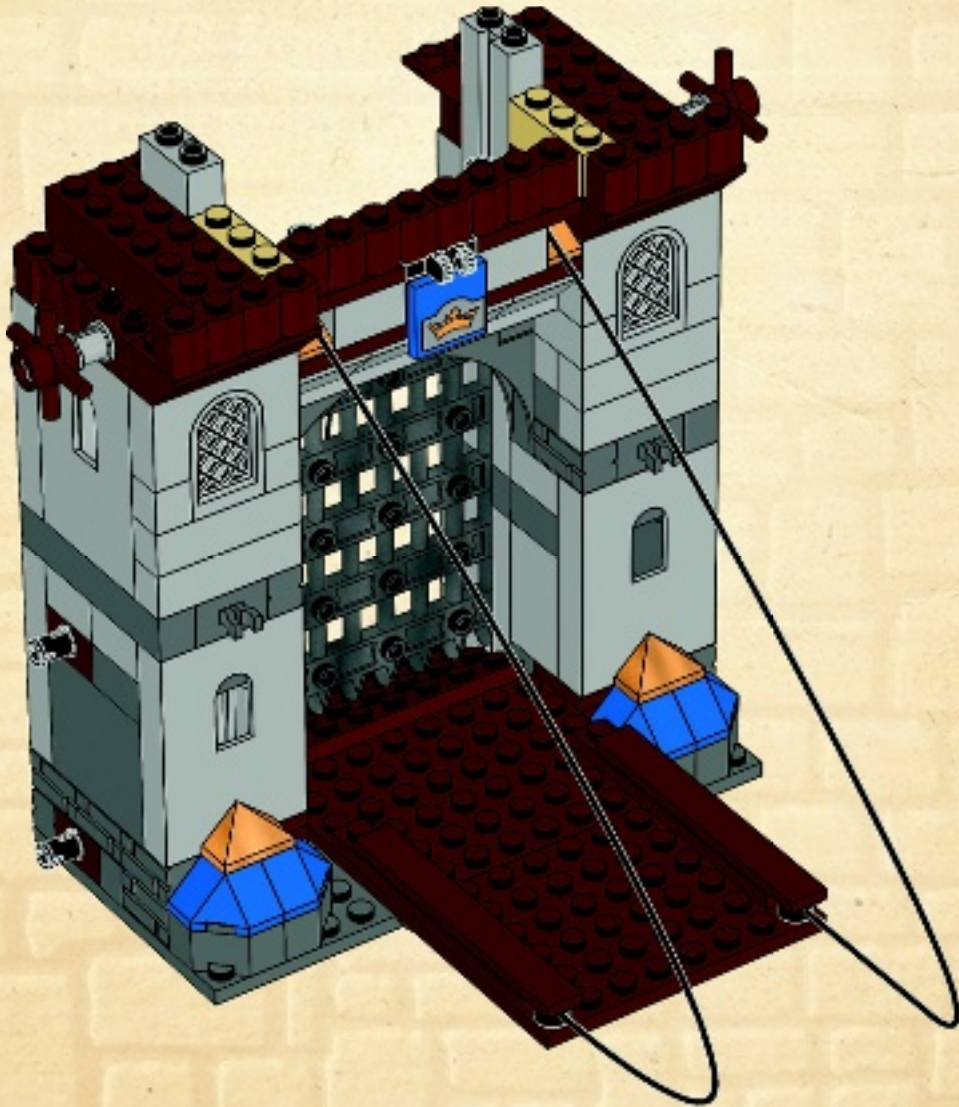





6x

37

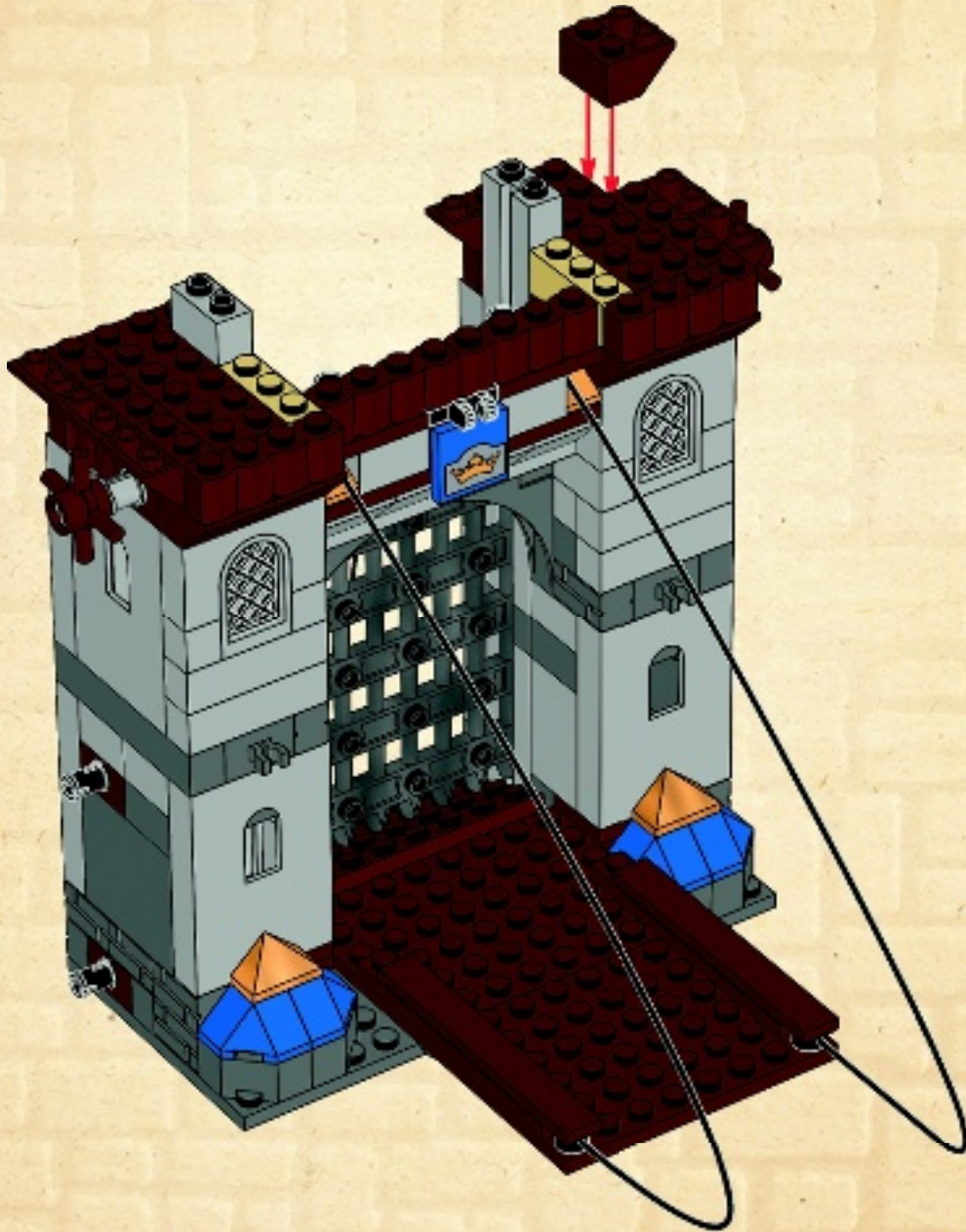



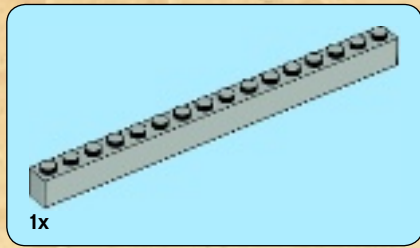

38

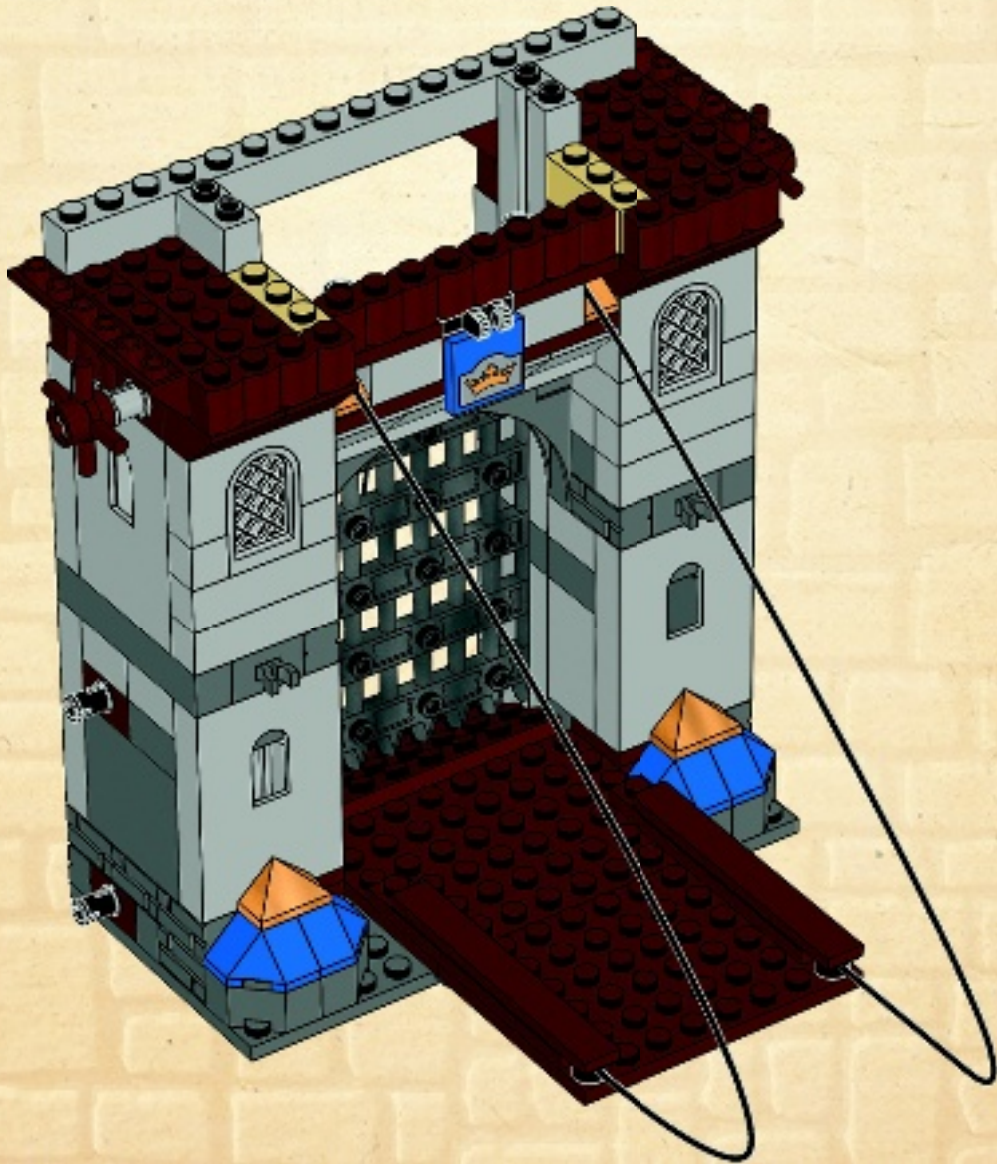



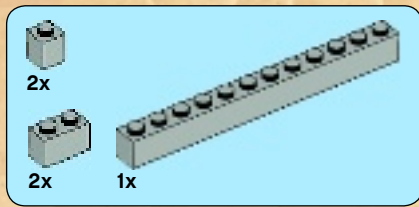

39

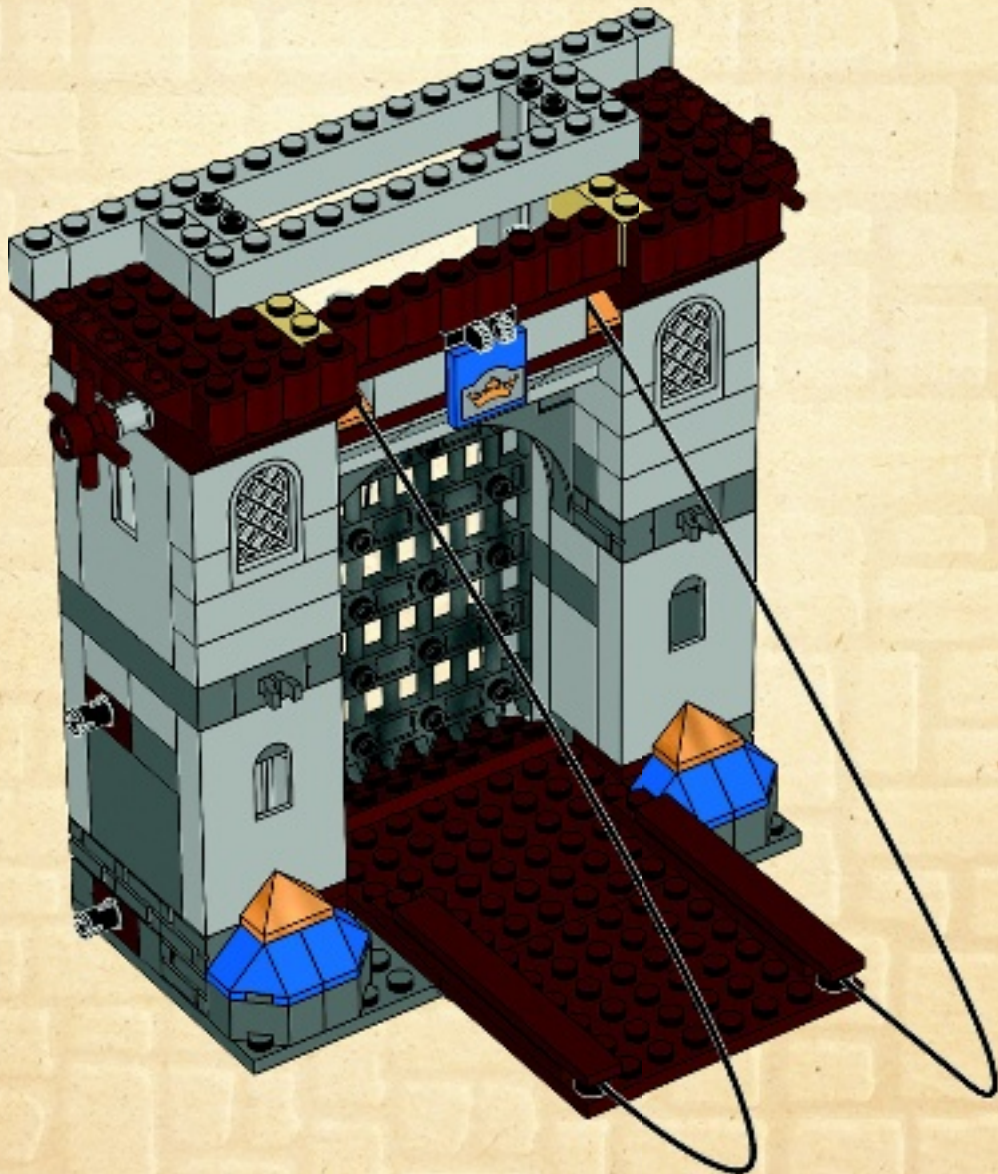



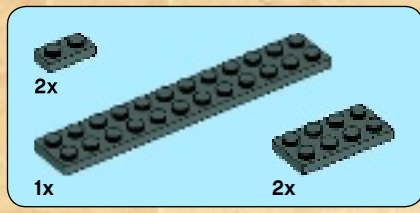

40

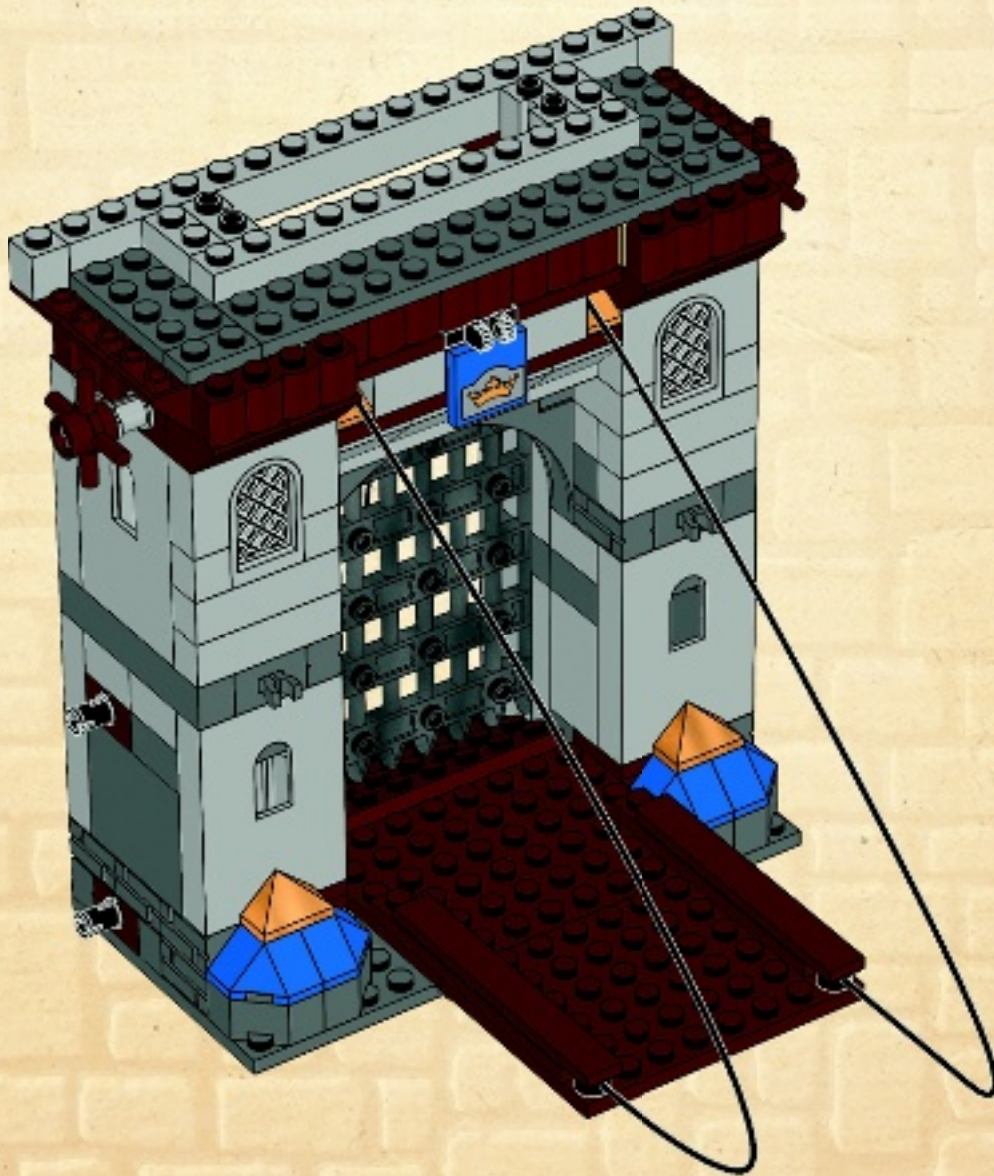



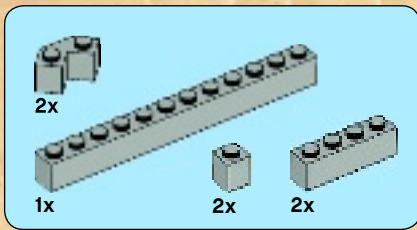

41

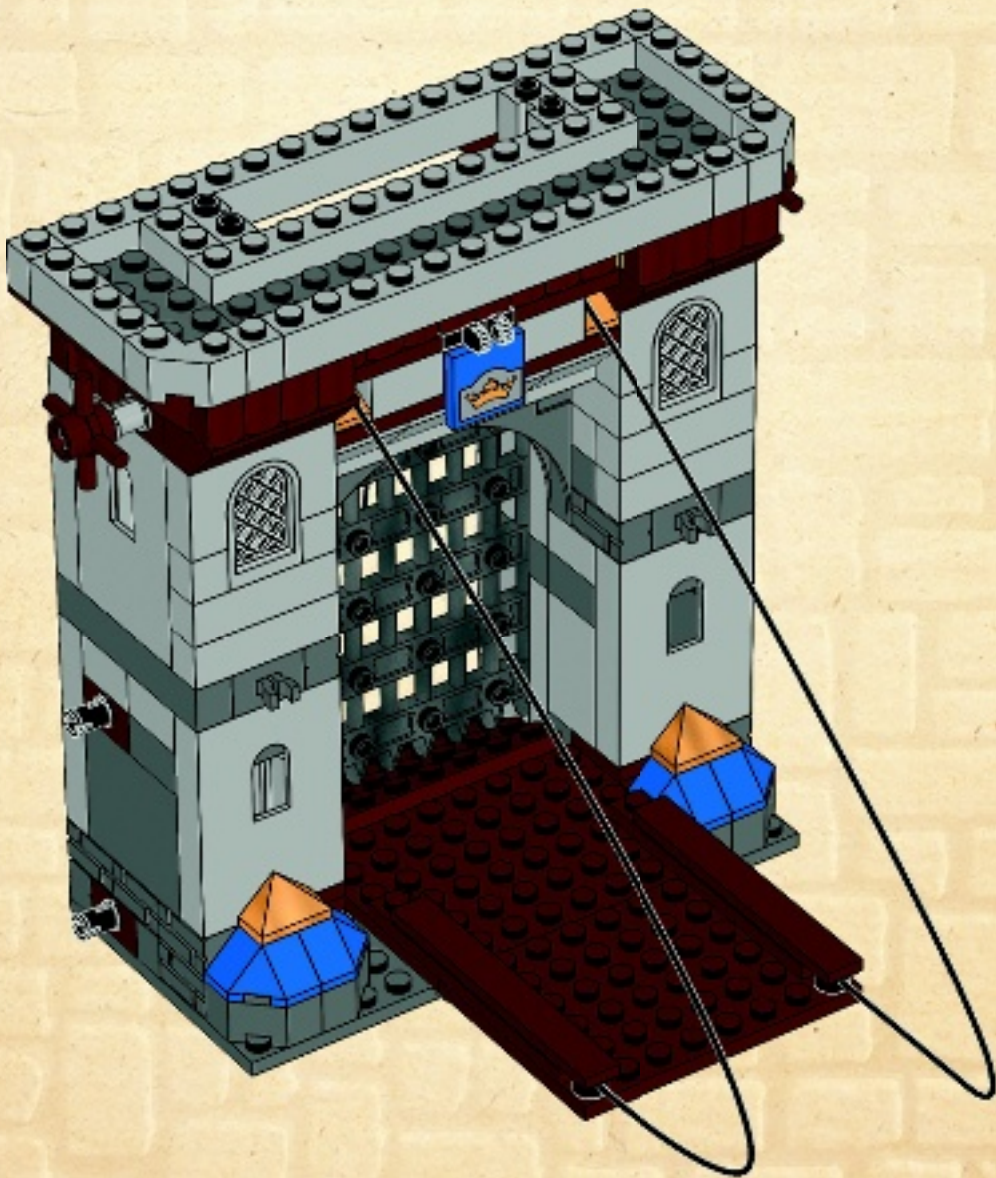





2x



2x

# 42

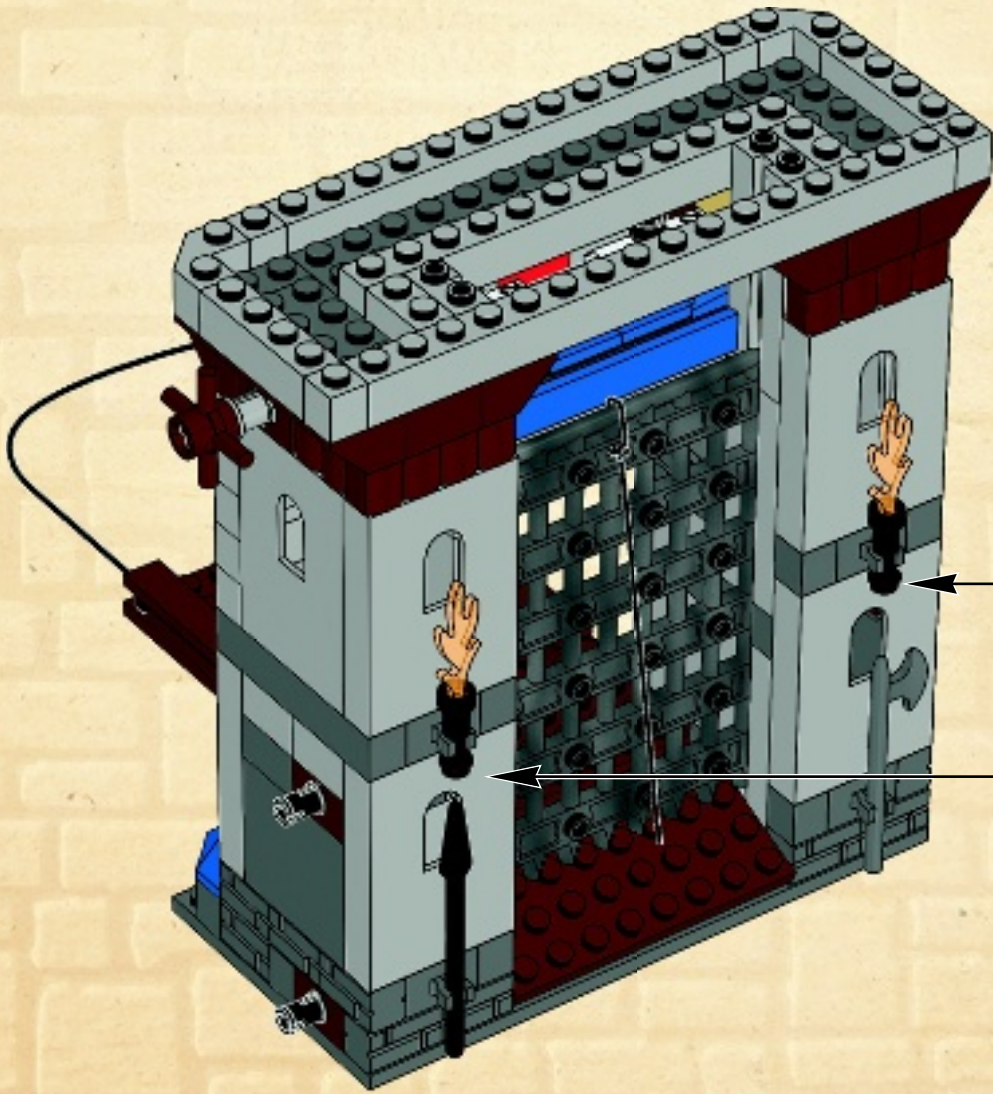
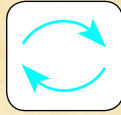

2x



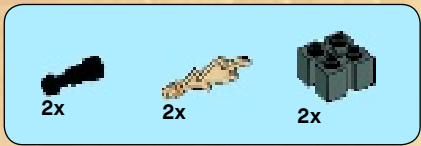

# 43

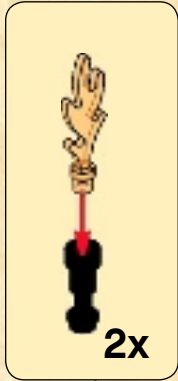
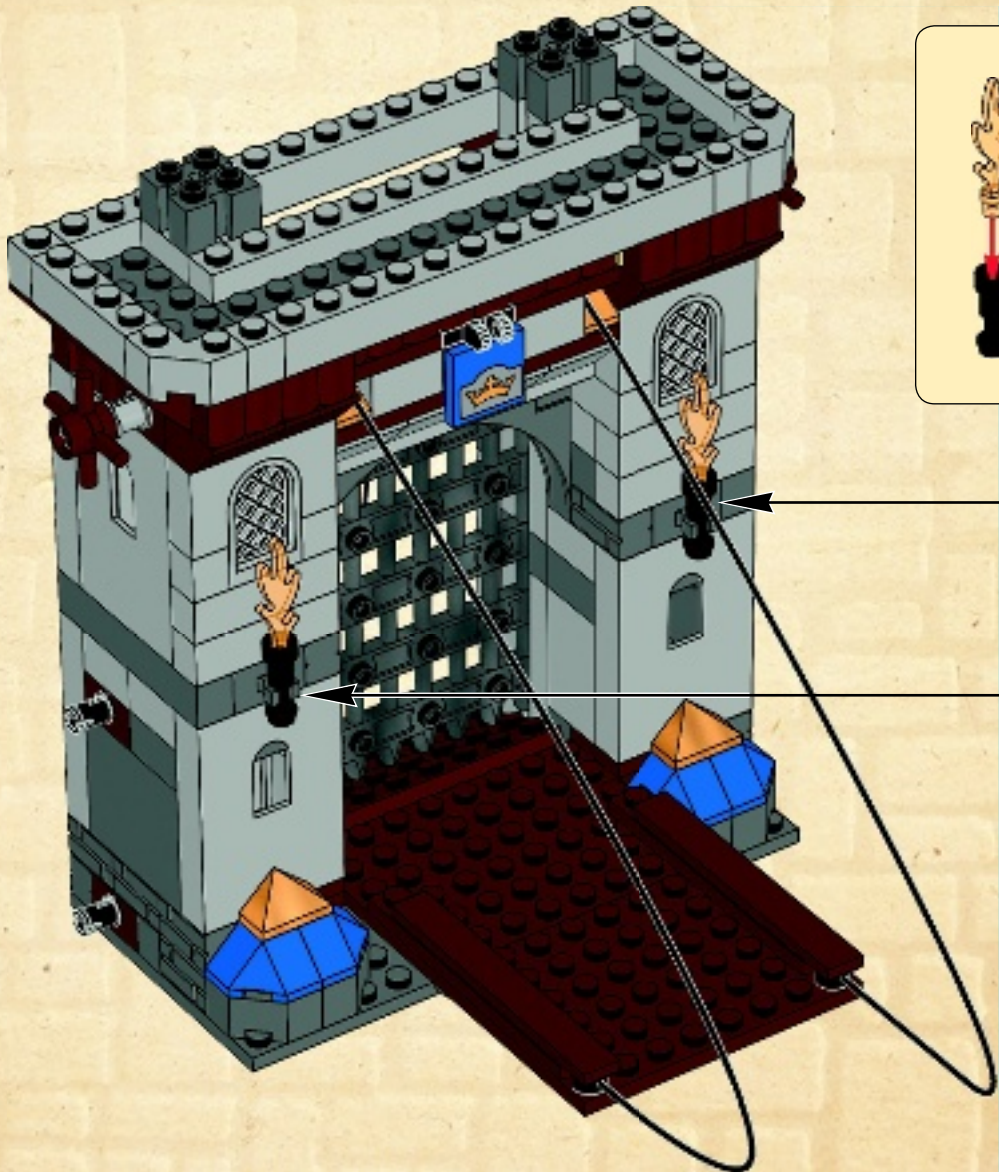





44

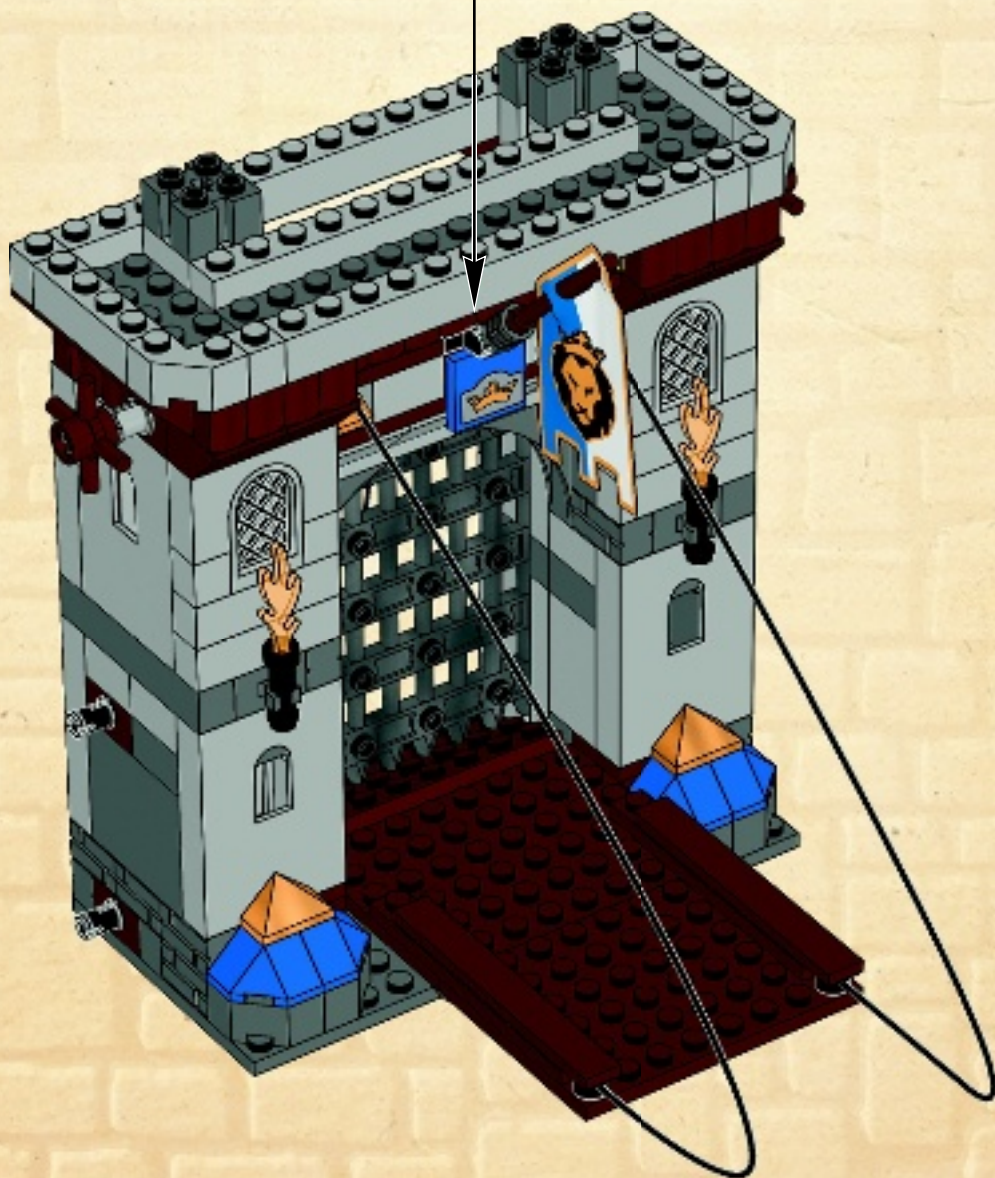



4

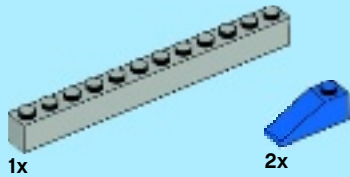
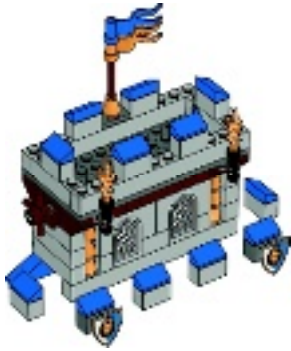

1x

2x

45

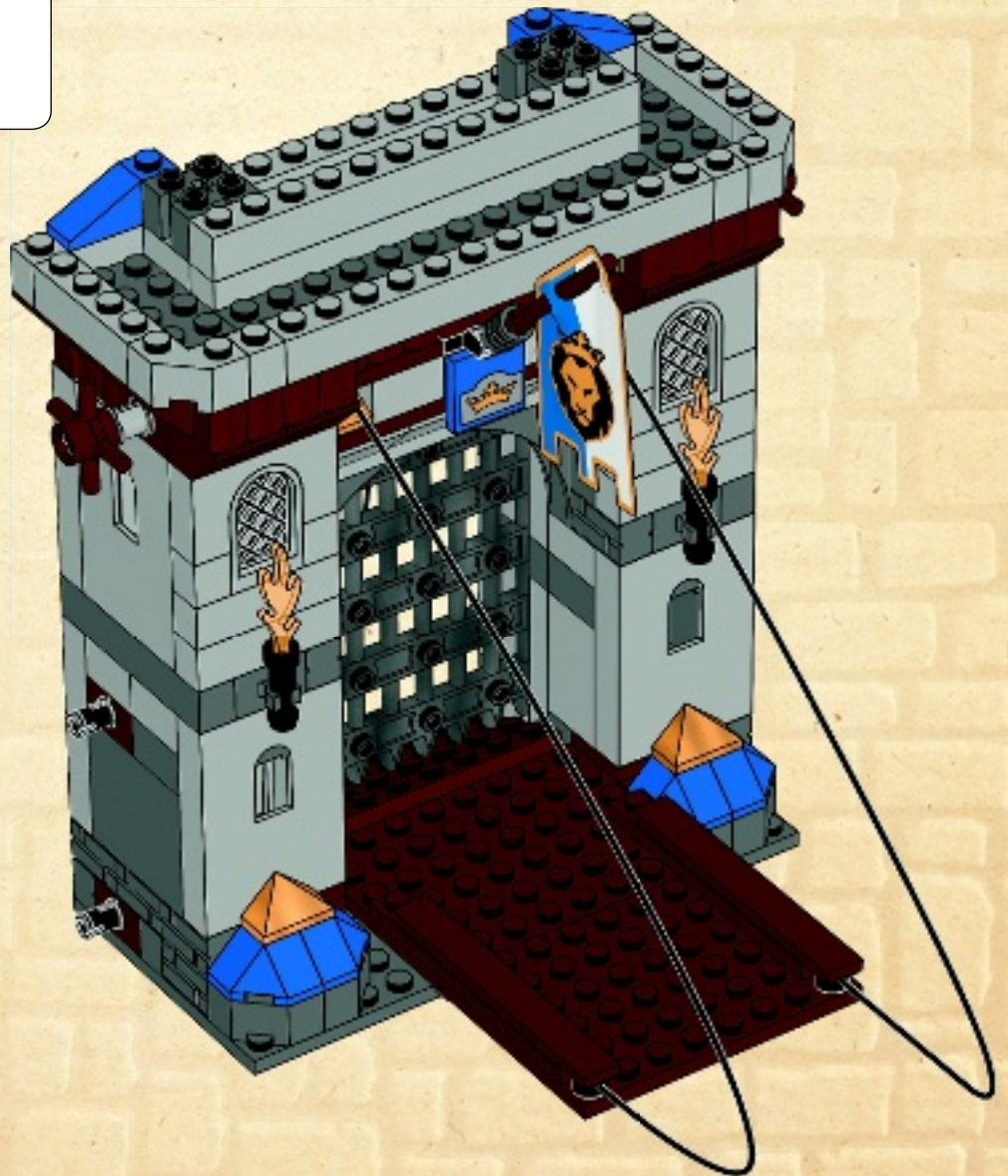





2x



4x

# 46

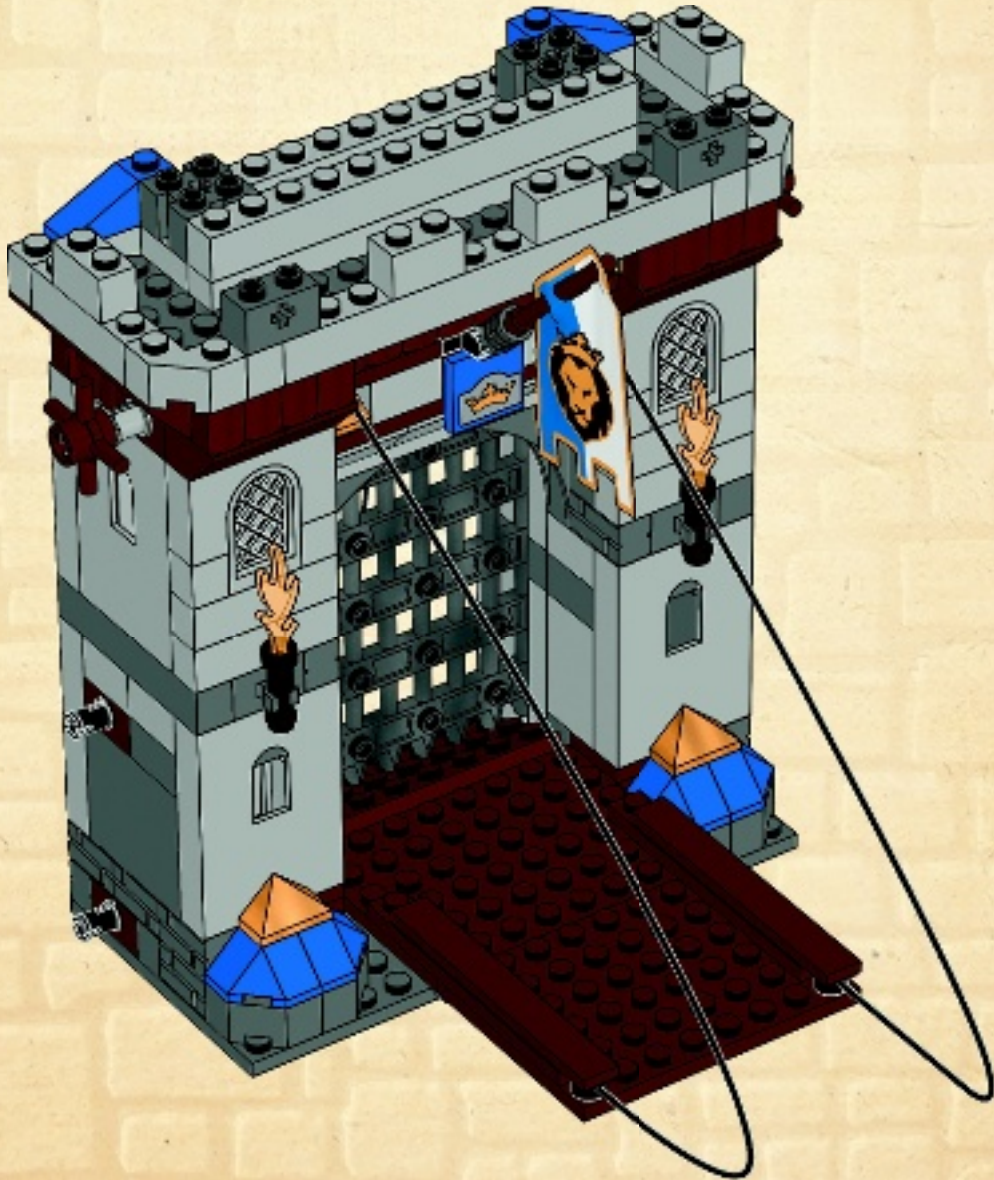





6x



2x

47

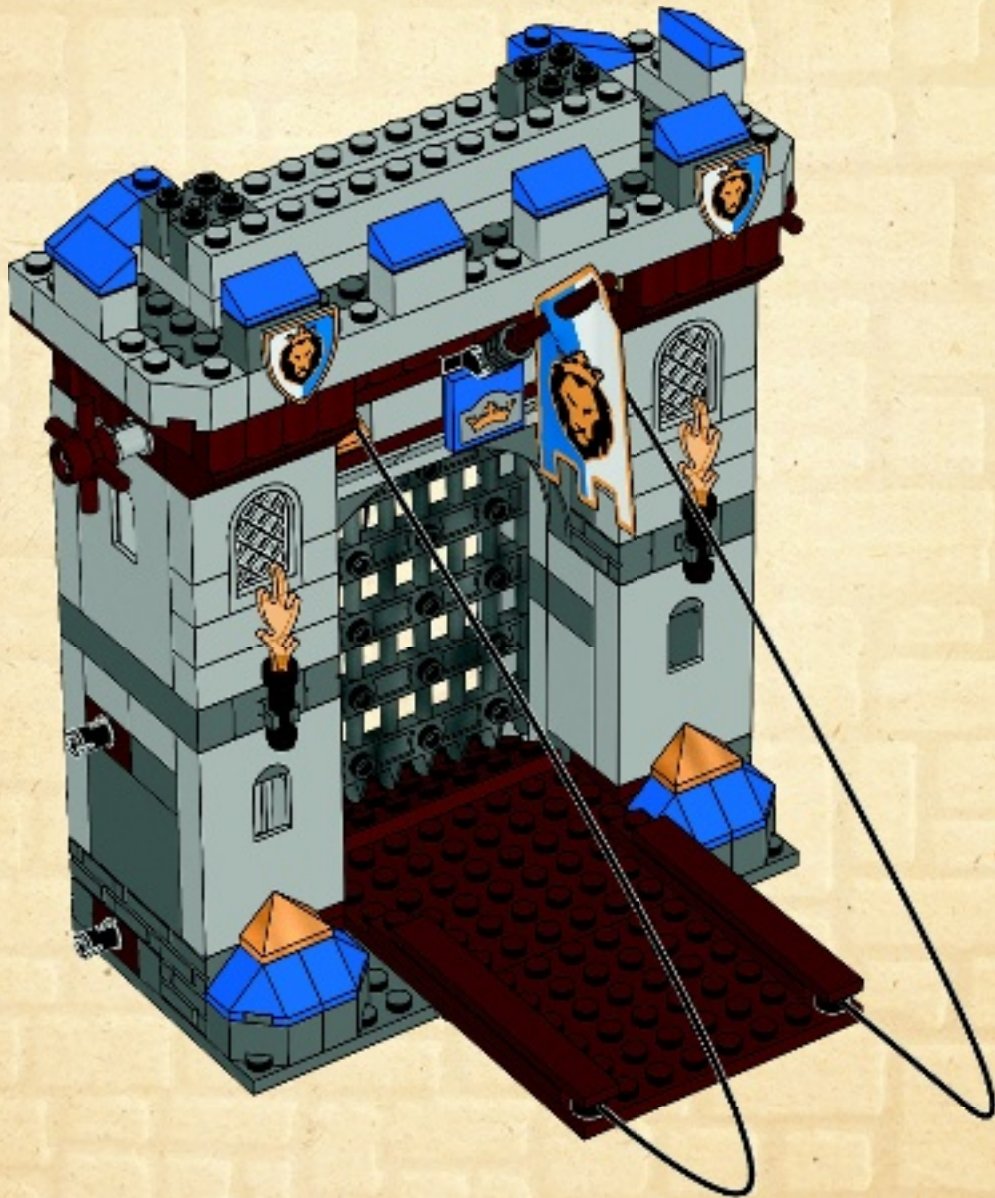





6x

# 48

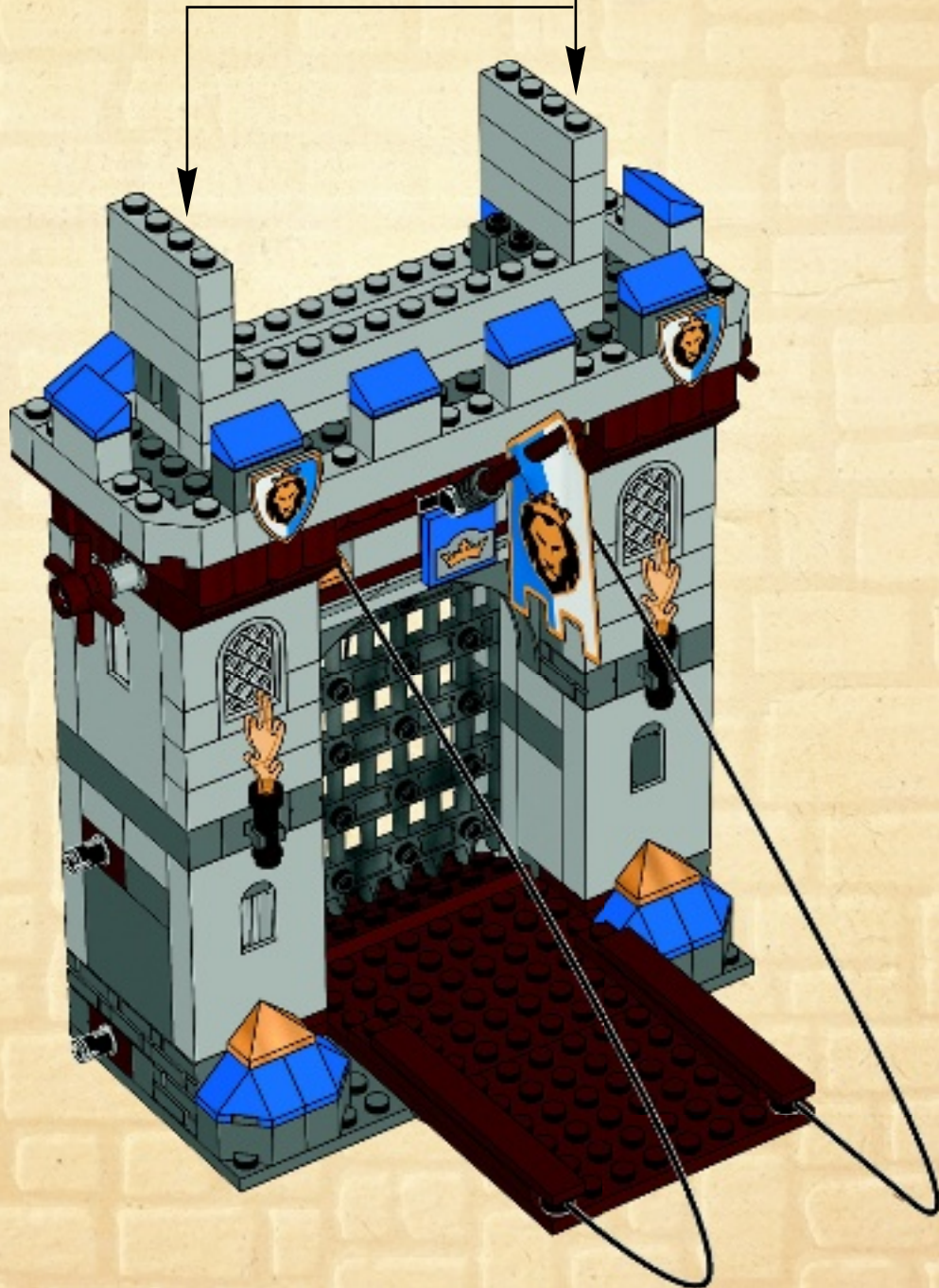
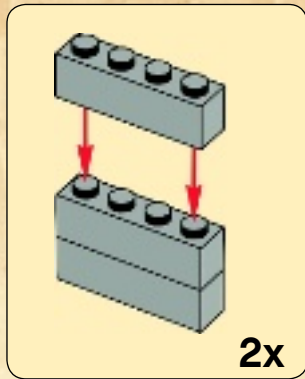



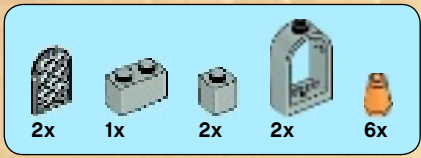

49

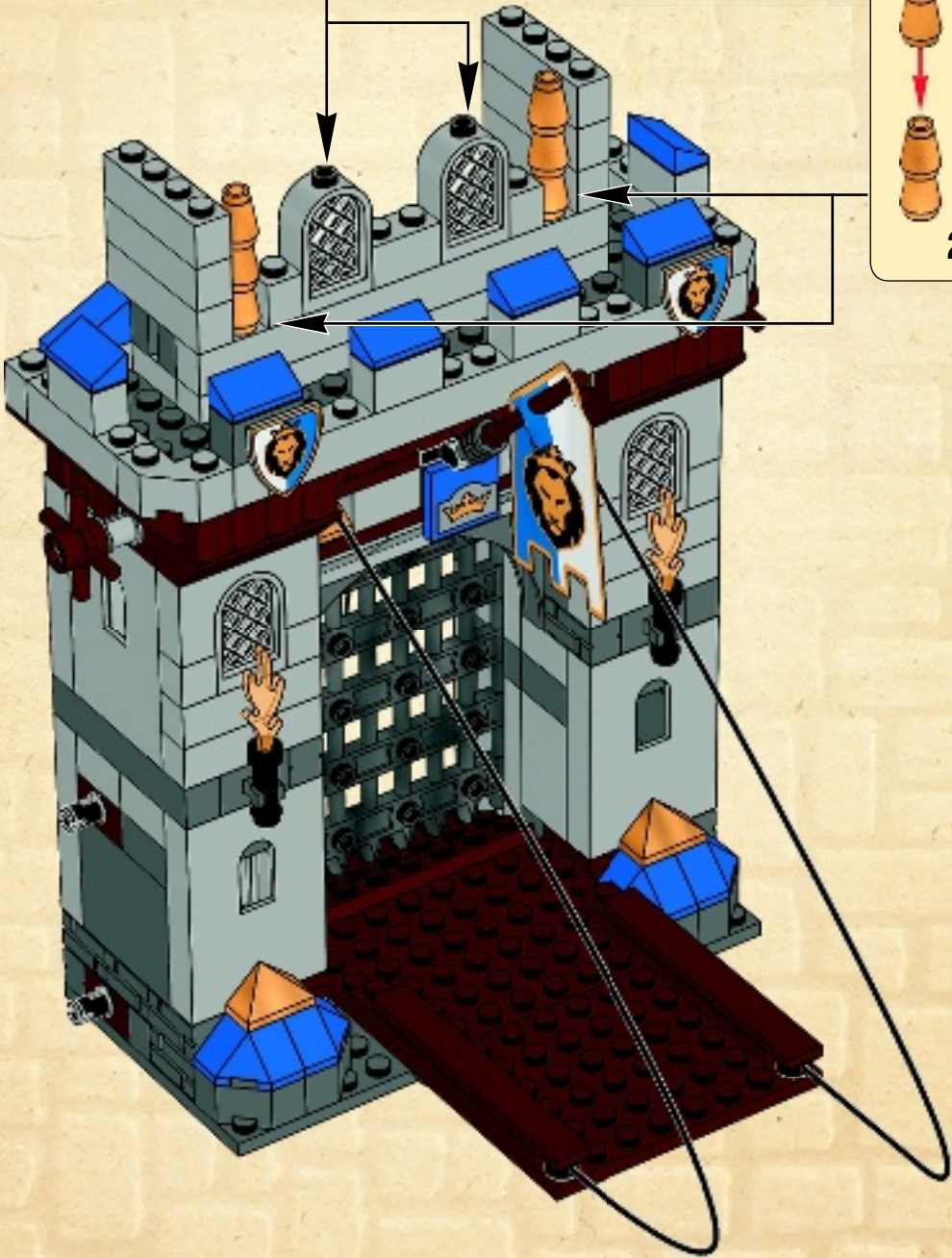
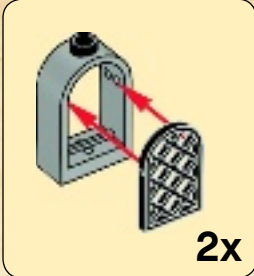



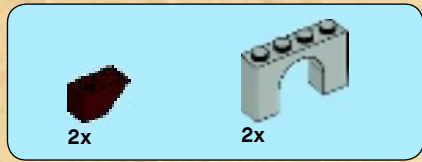

50

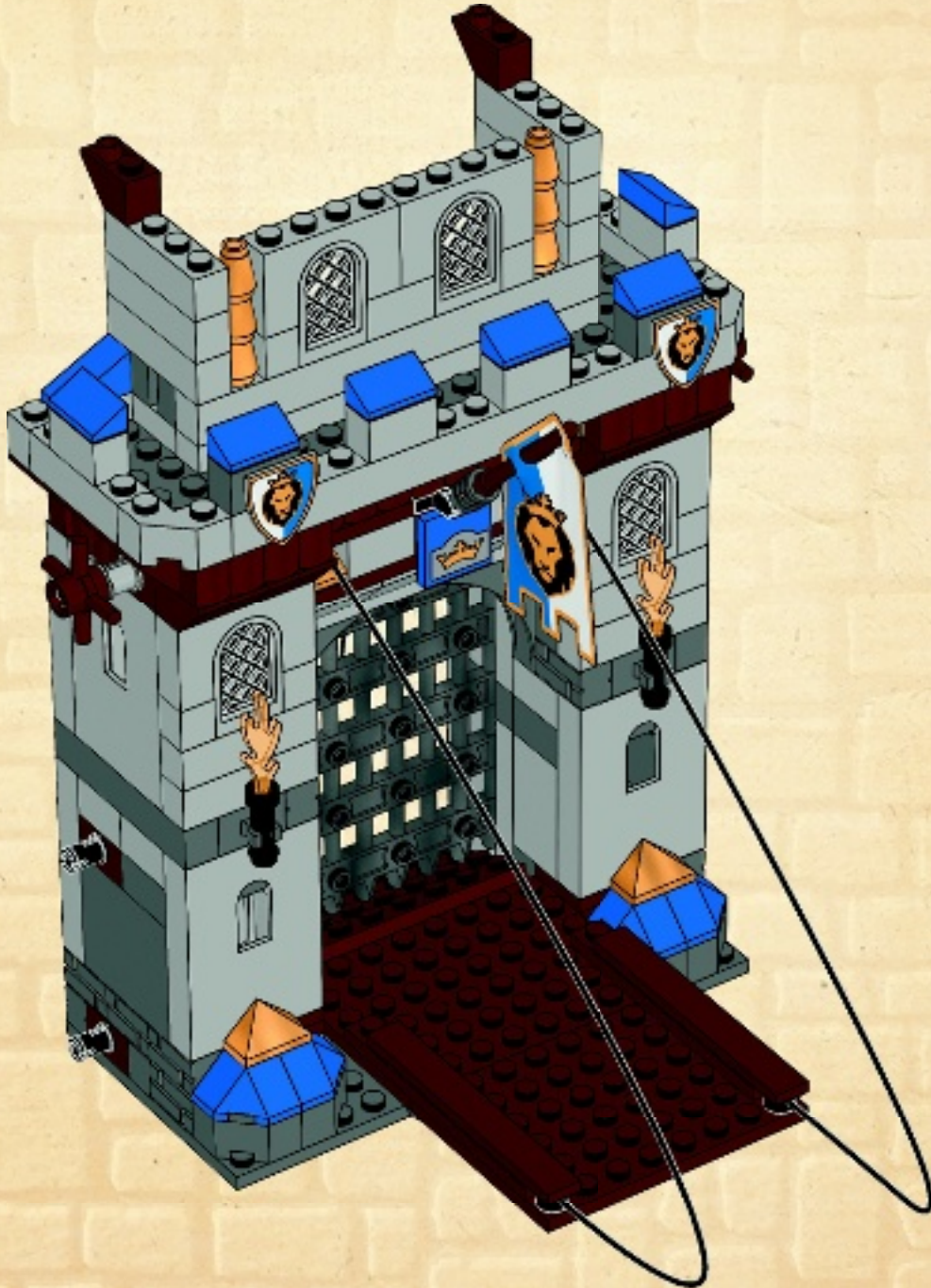



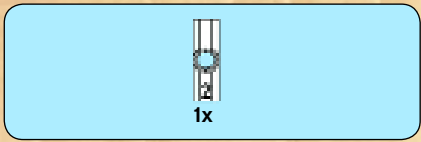

1



3

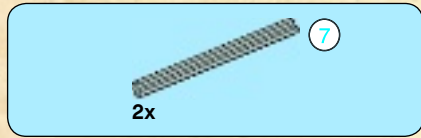
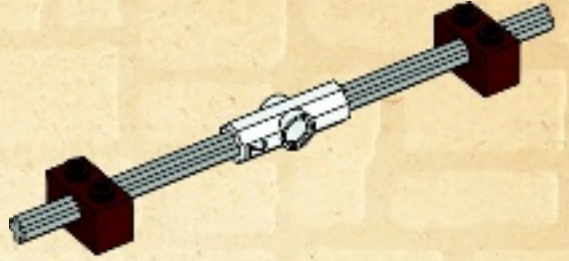

2

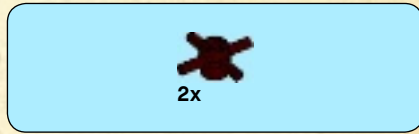
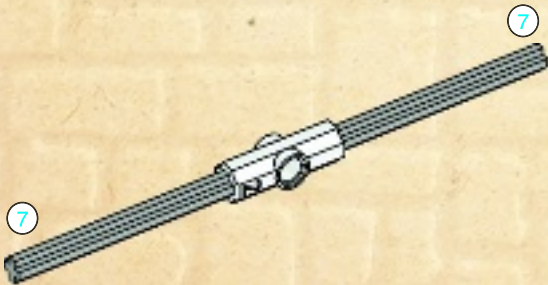

4

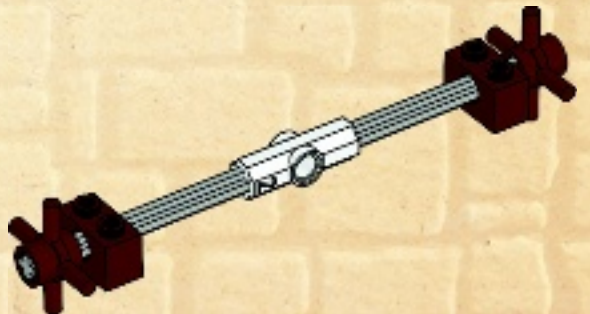



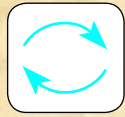

51

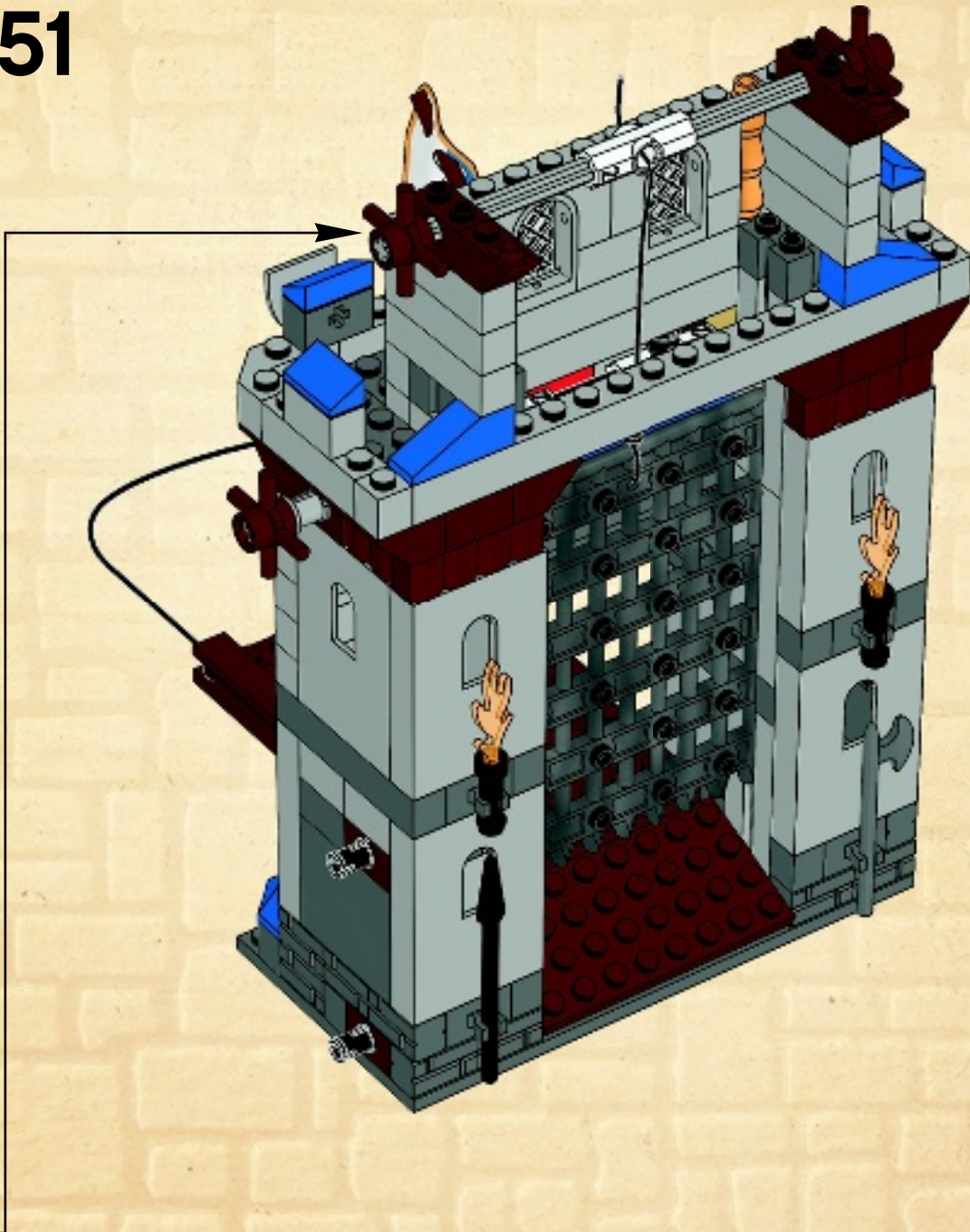



52

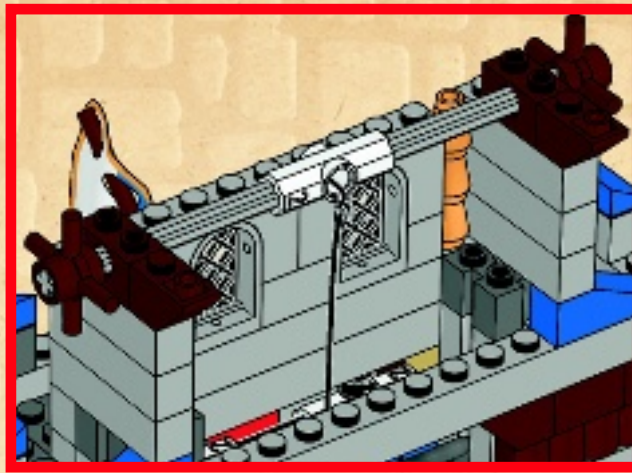

53

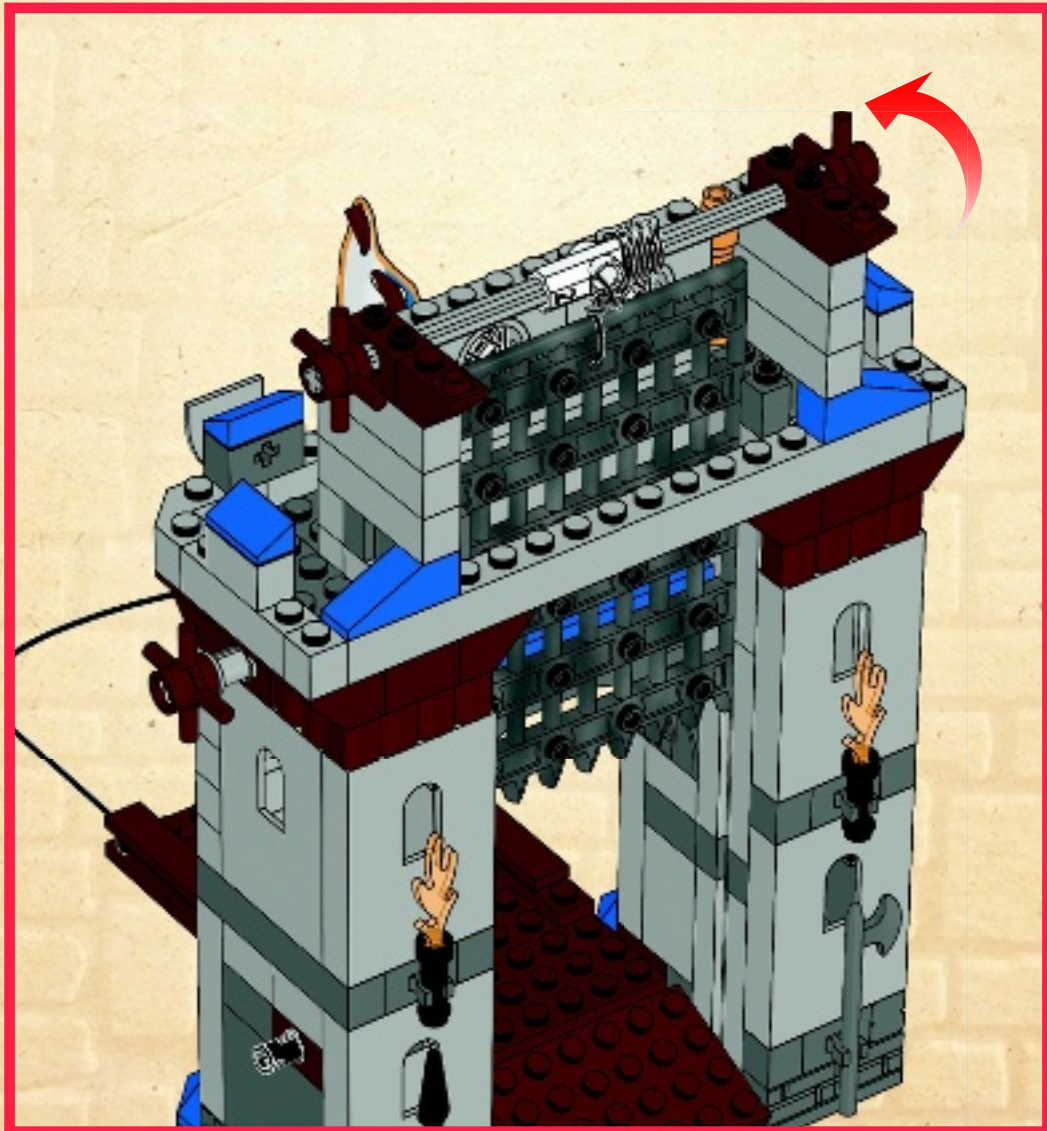



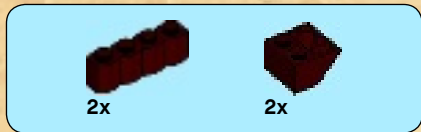



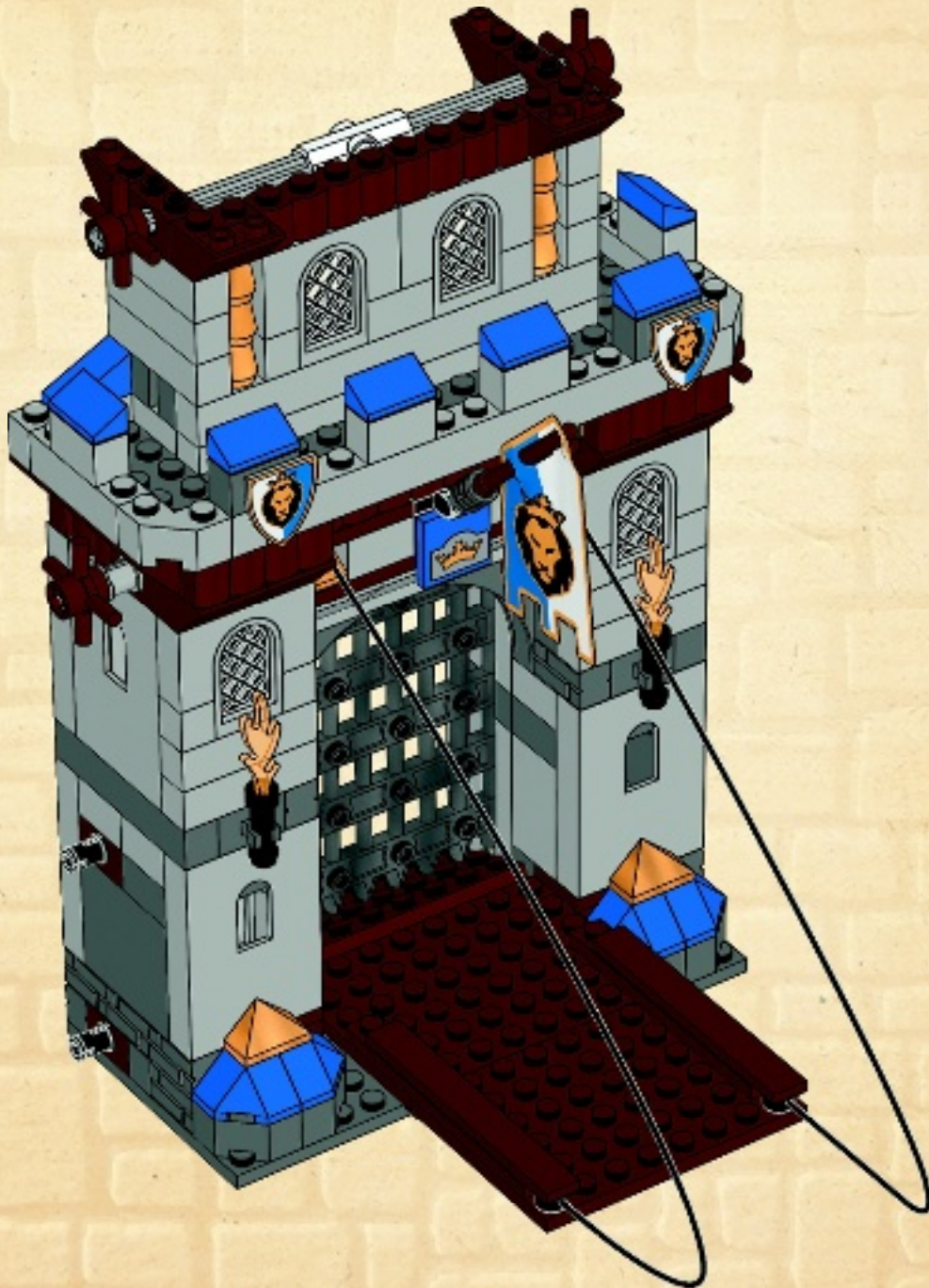

54





	
2x	1x
	
2x	2x

55

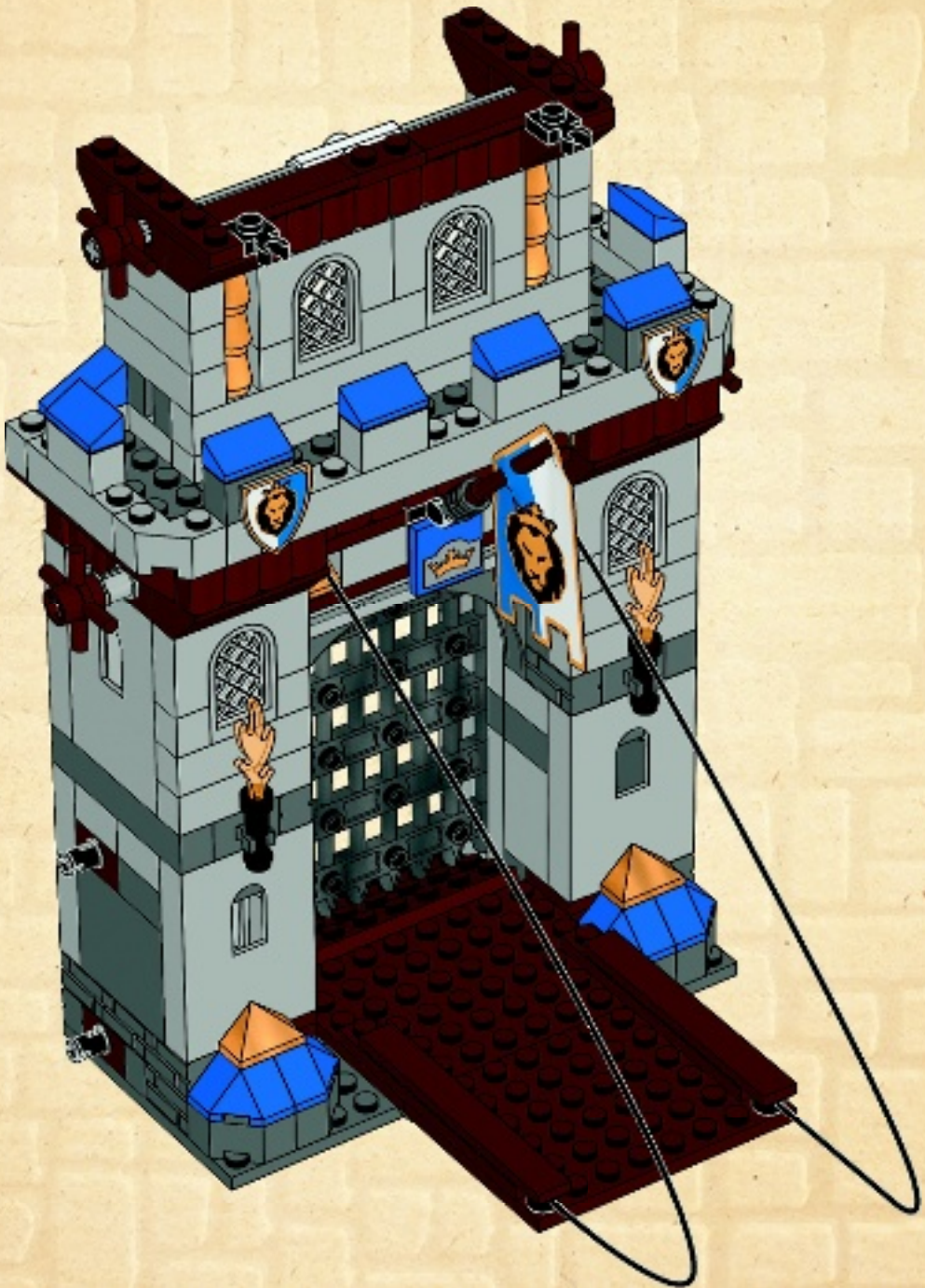



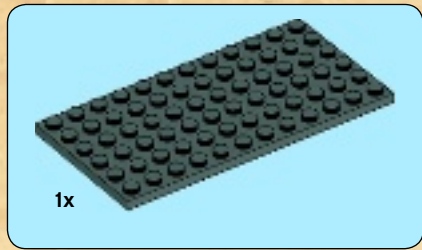

56

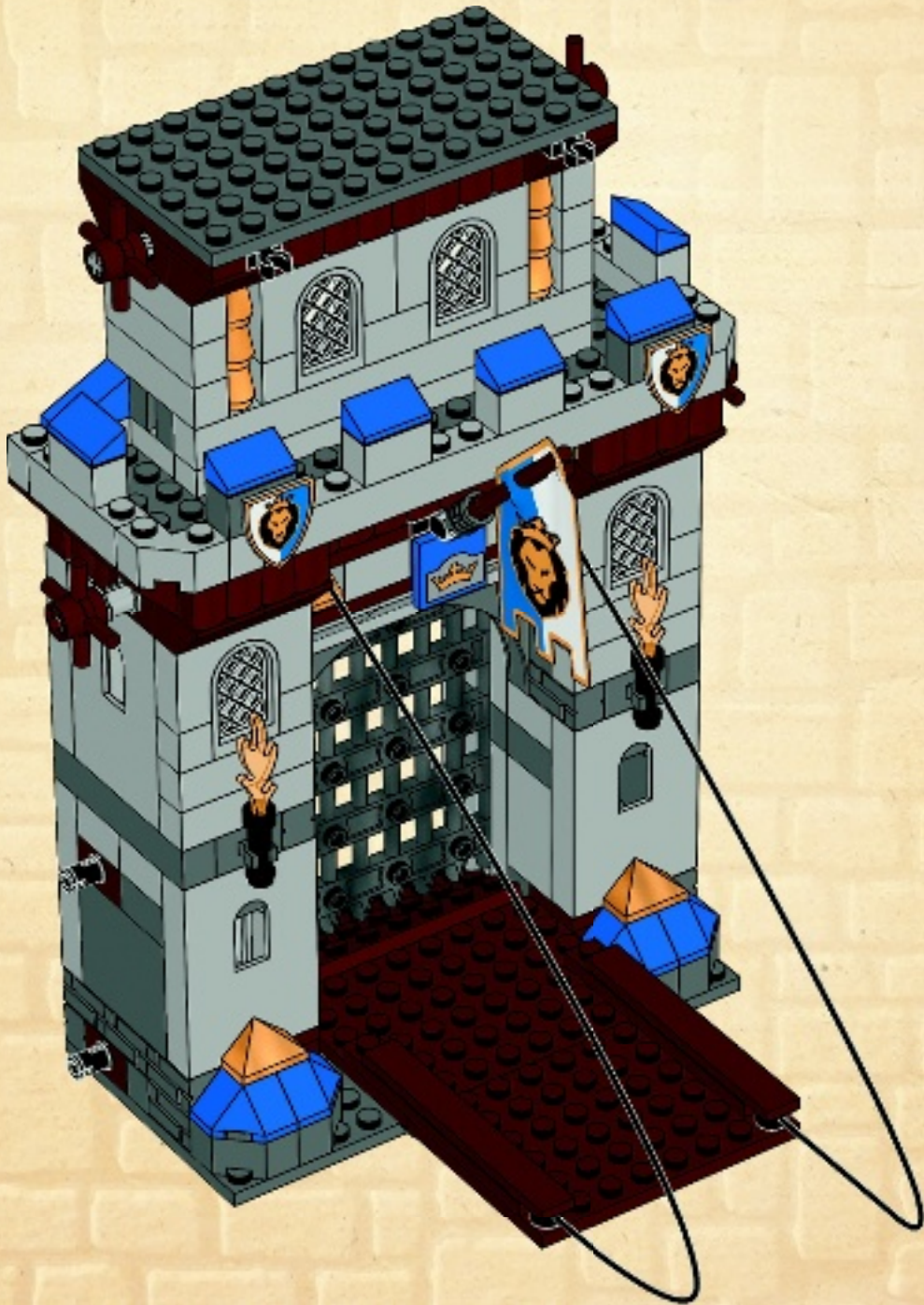



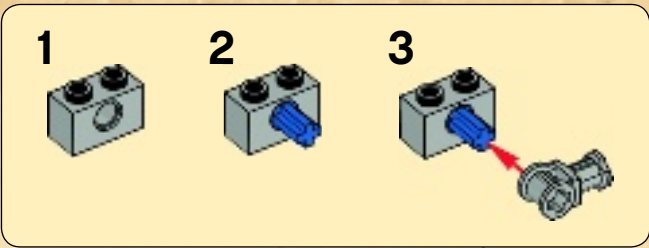
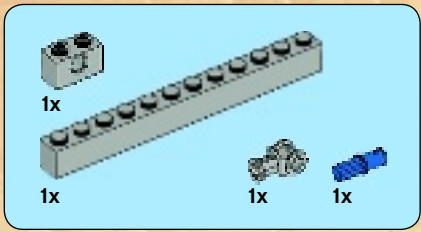

57

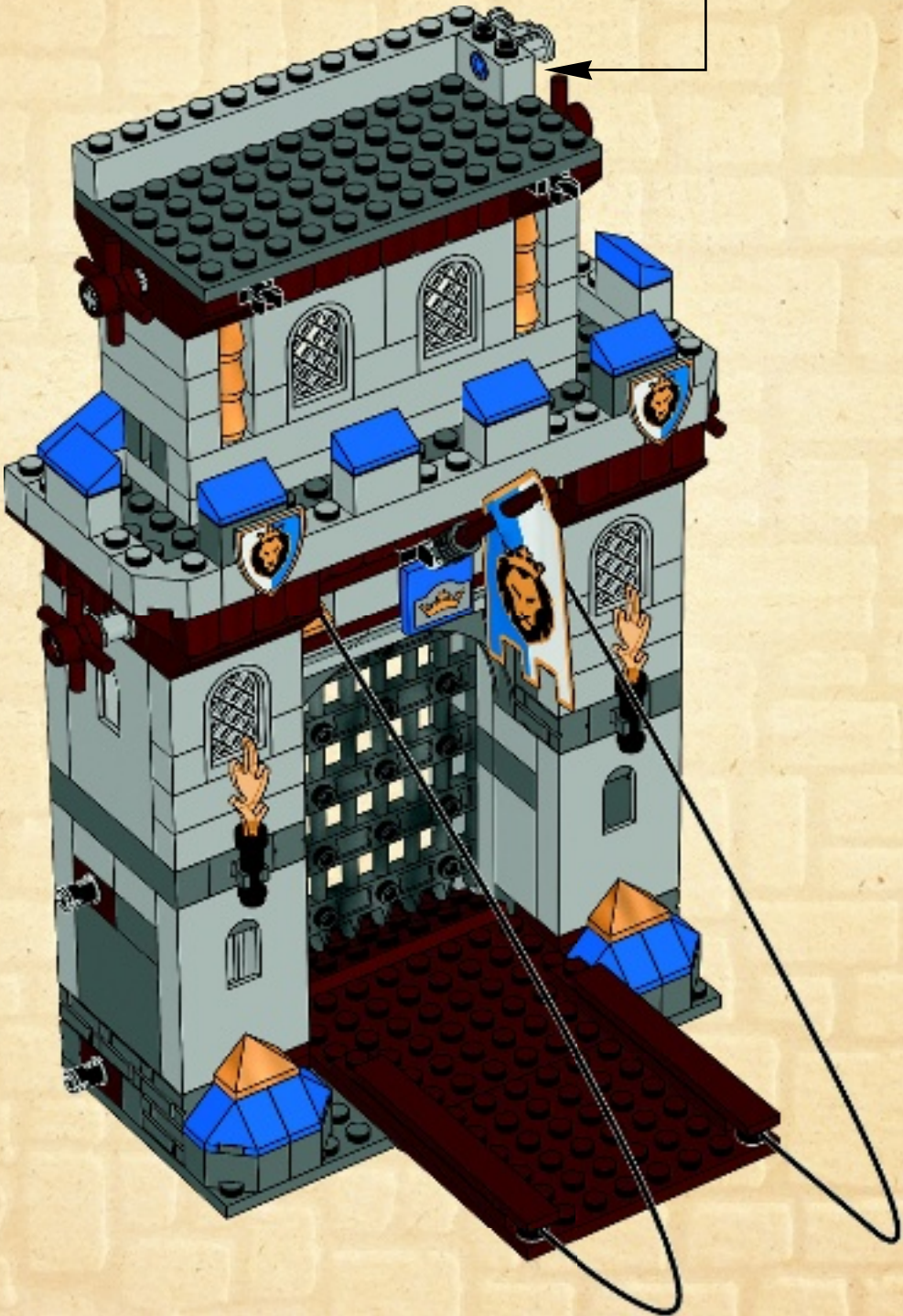



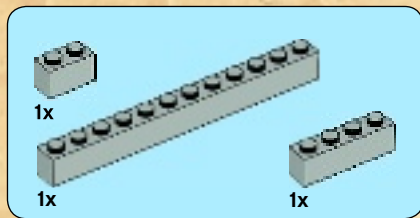

58

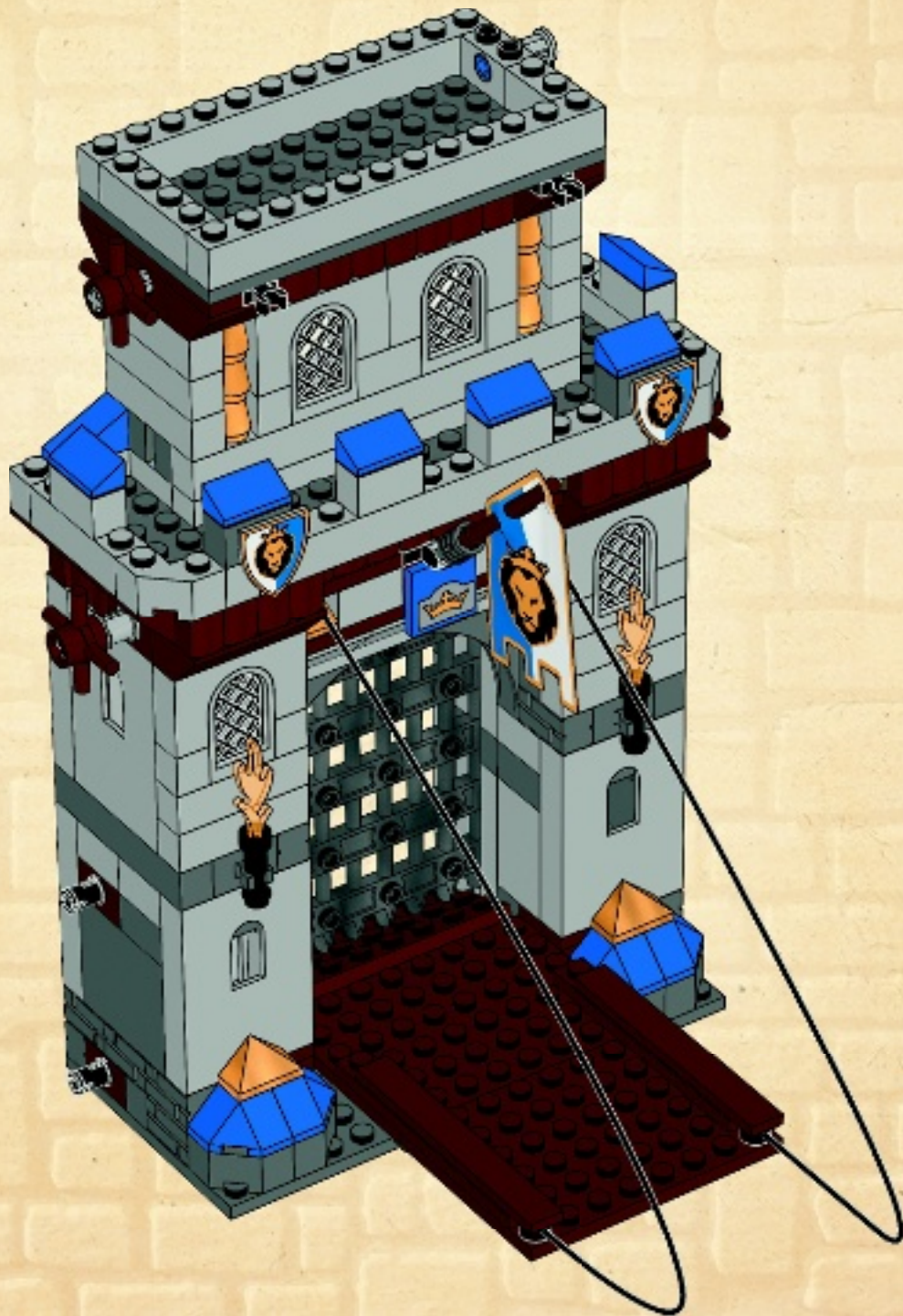



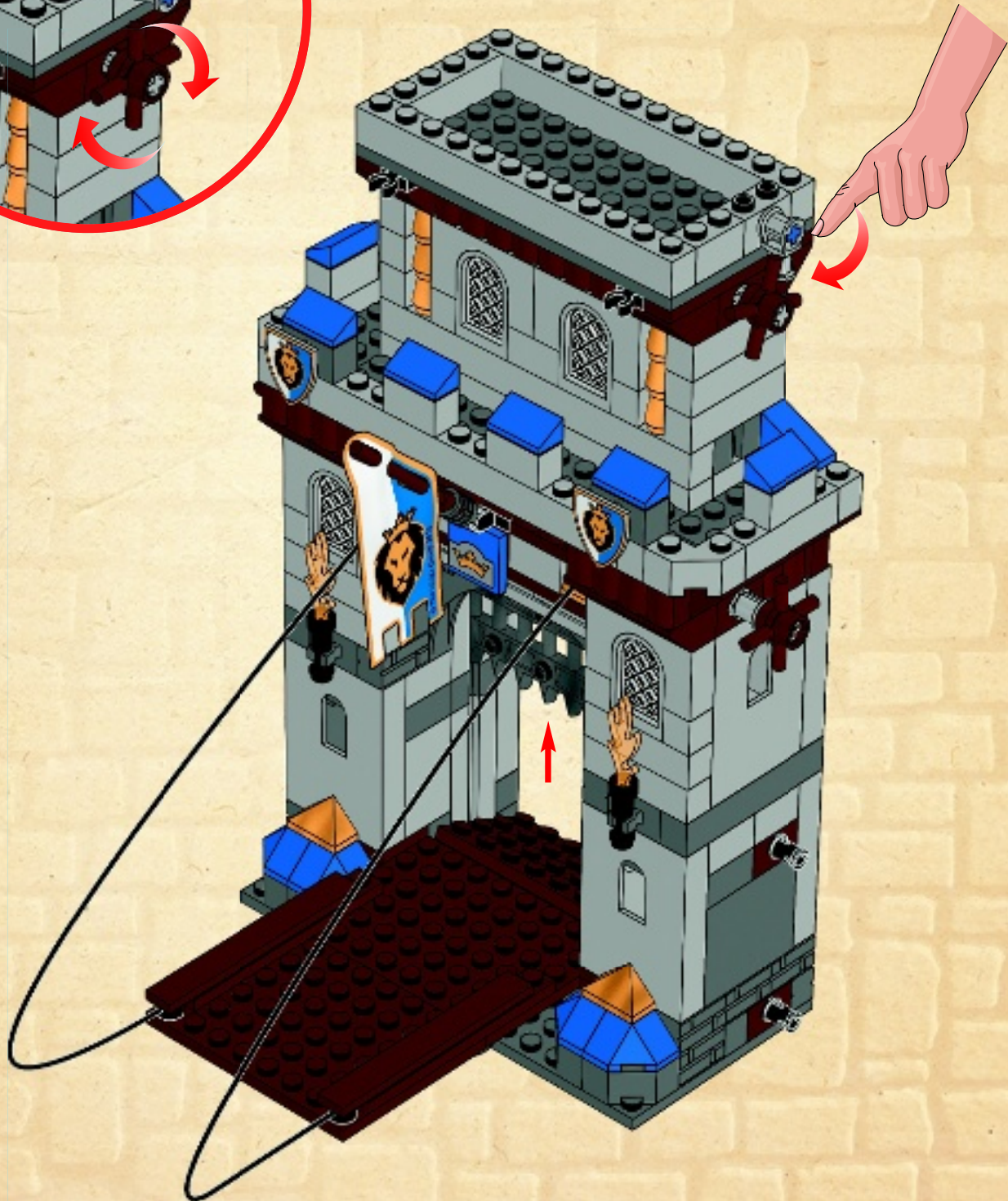
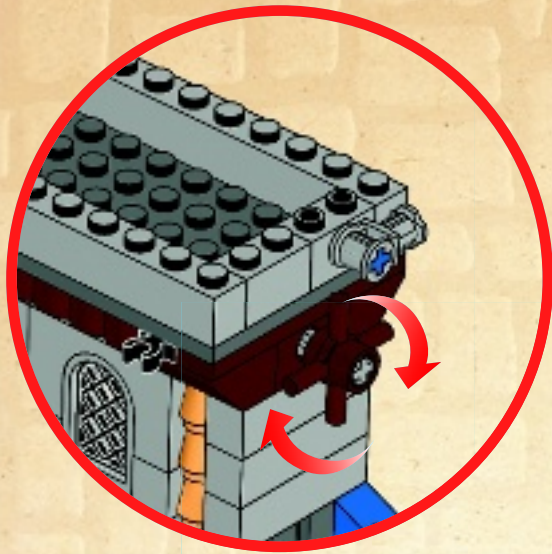





1x



6x

# 59

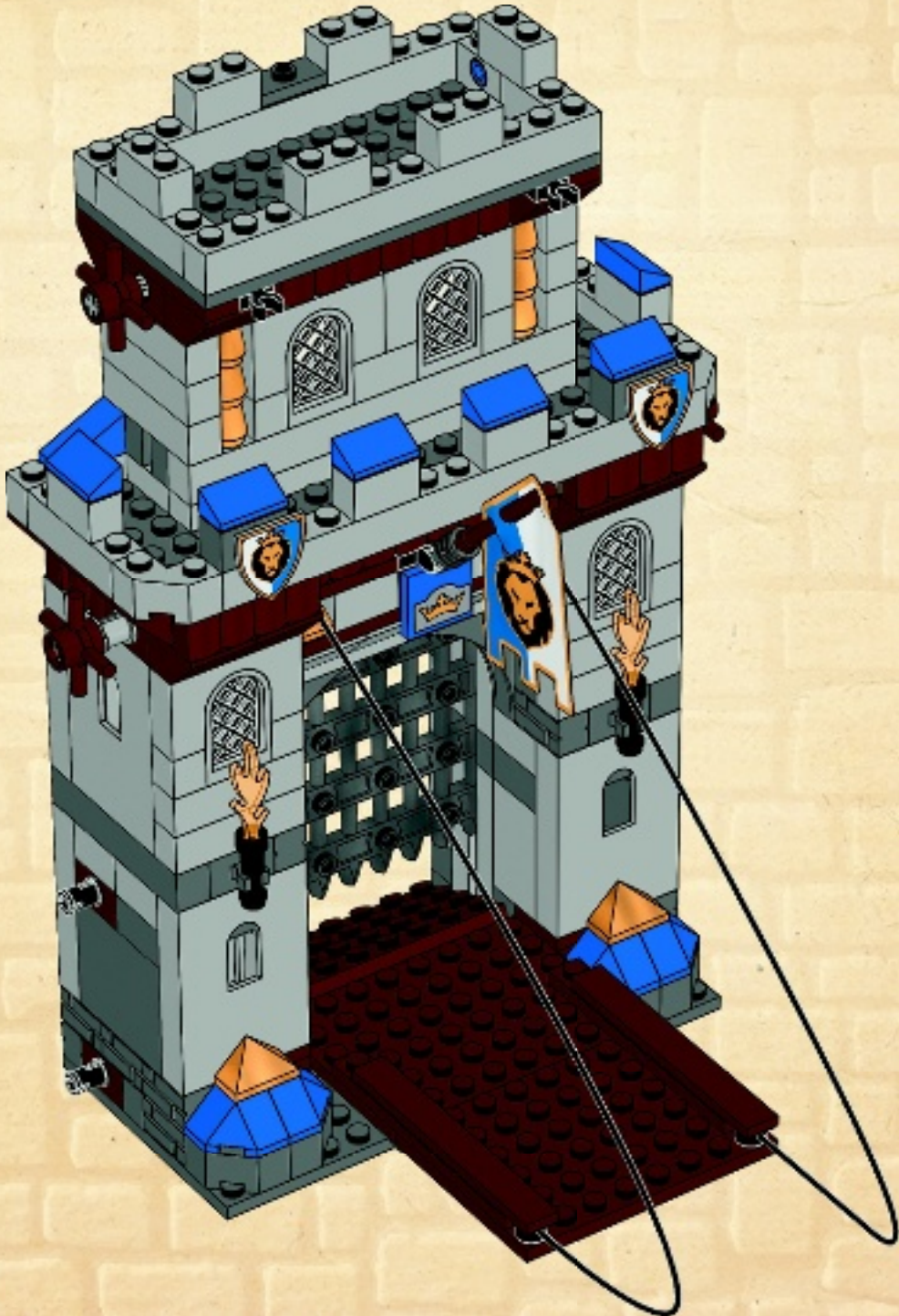





60

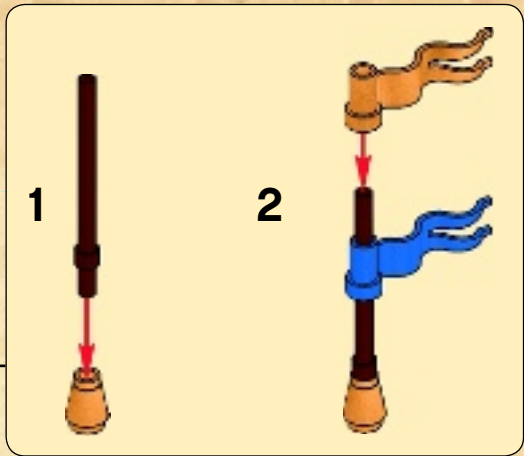
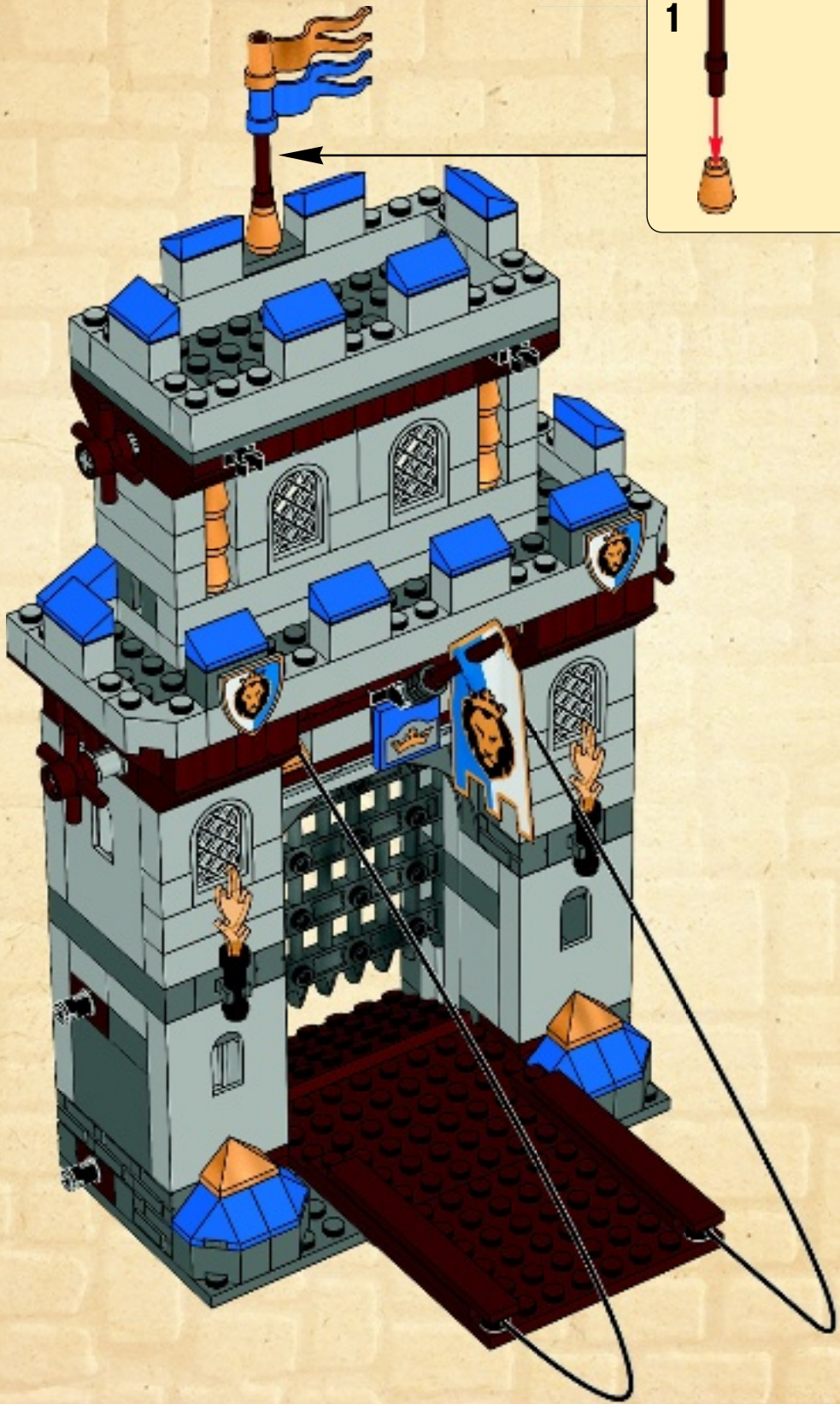





2x



2x

# 61

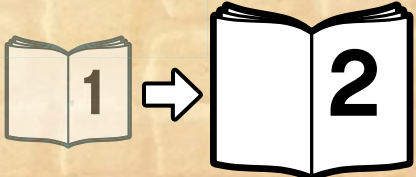
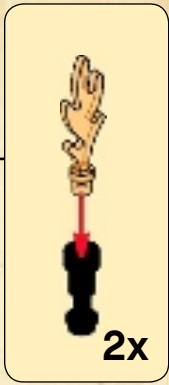
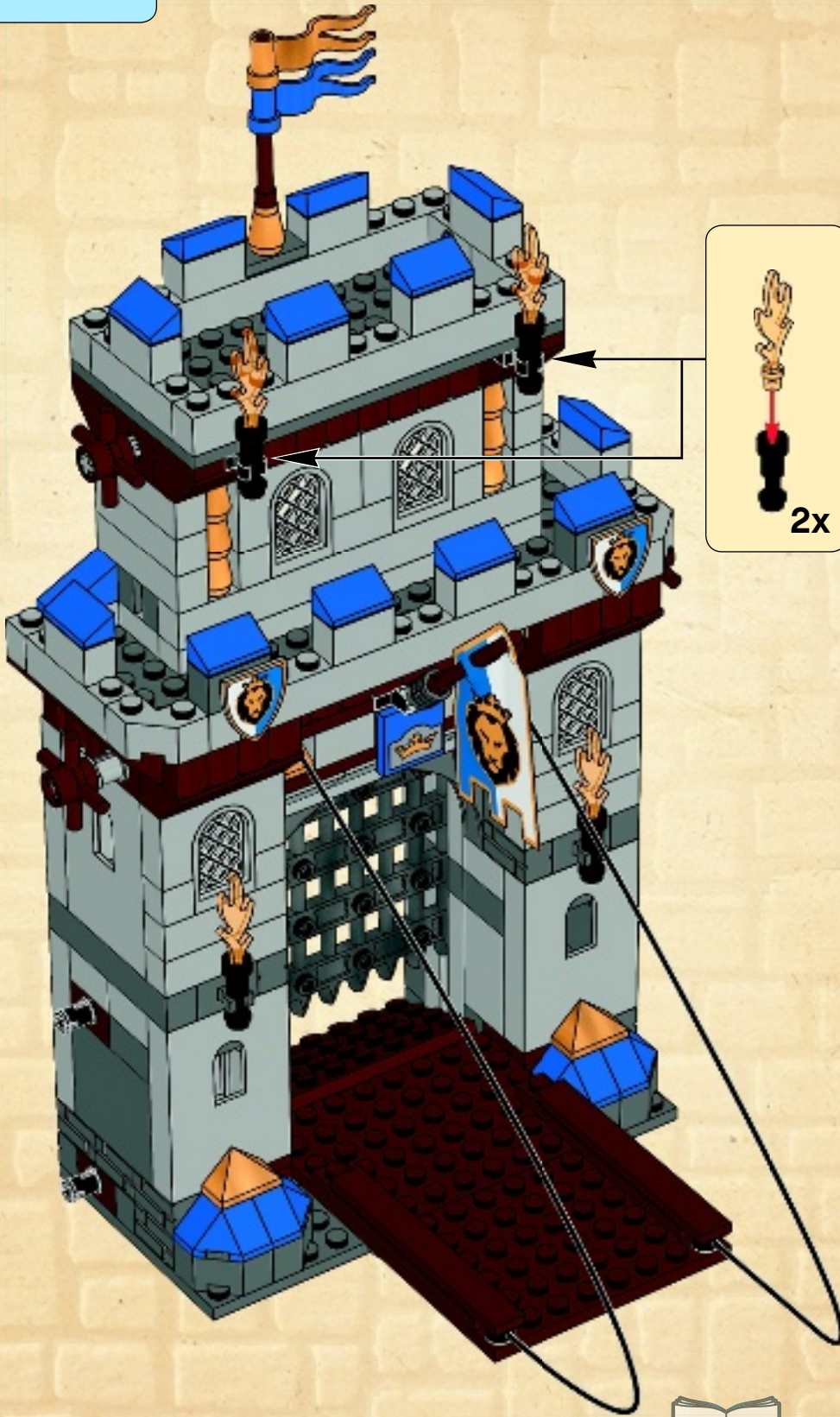









[LEGO.com/castle](http://LEGO.com/castle)